

alberta[®]
Made in Italy



**ORANGE
COLLECTION**

03.2023

INDICE - INDEX

DIVANI _____	4
POLTRONE _____	138
riepilogo - summary _____	155
finiture - finishing _____	169
dati tecnici - technical data _____	175

DIVANI - SOFAS



ALCAZAR _____ 4



VEGA _____ 24



COLLINS 2 _____ 44



PITAGORA _____ 54



MANHATTAN 2 _____ 70



BROADWAY 2 _____ 86



THEO/THEO SLIM _____ 100



SUMMER _____ 118

POLTRONE - ARMCHAIRS



HONOLULU _____ 138



KALINDA _____ 142



ELLE _____ 146



GOSSIP _____ 150

ALCAZAR

designed by ALBERTA STYLE DEPARTMENT







SWEET JANE









ALCAZAR







ALCAZAR



VEGA

designed by ALBERTA STYLE DEPARTMENT















VEGA









COLLINS 2

designed by ALBERTA STYLE DEPARTMENT









COLLINS 2



PITAGORA

designed by GOLDEN YOUNG STUDIO

















MANHATTAN 2

designed by ALBERTA STYLE DEPARTMENT











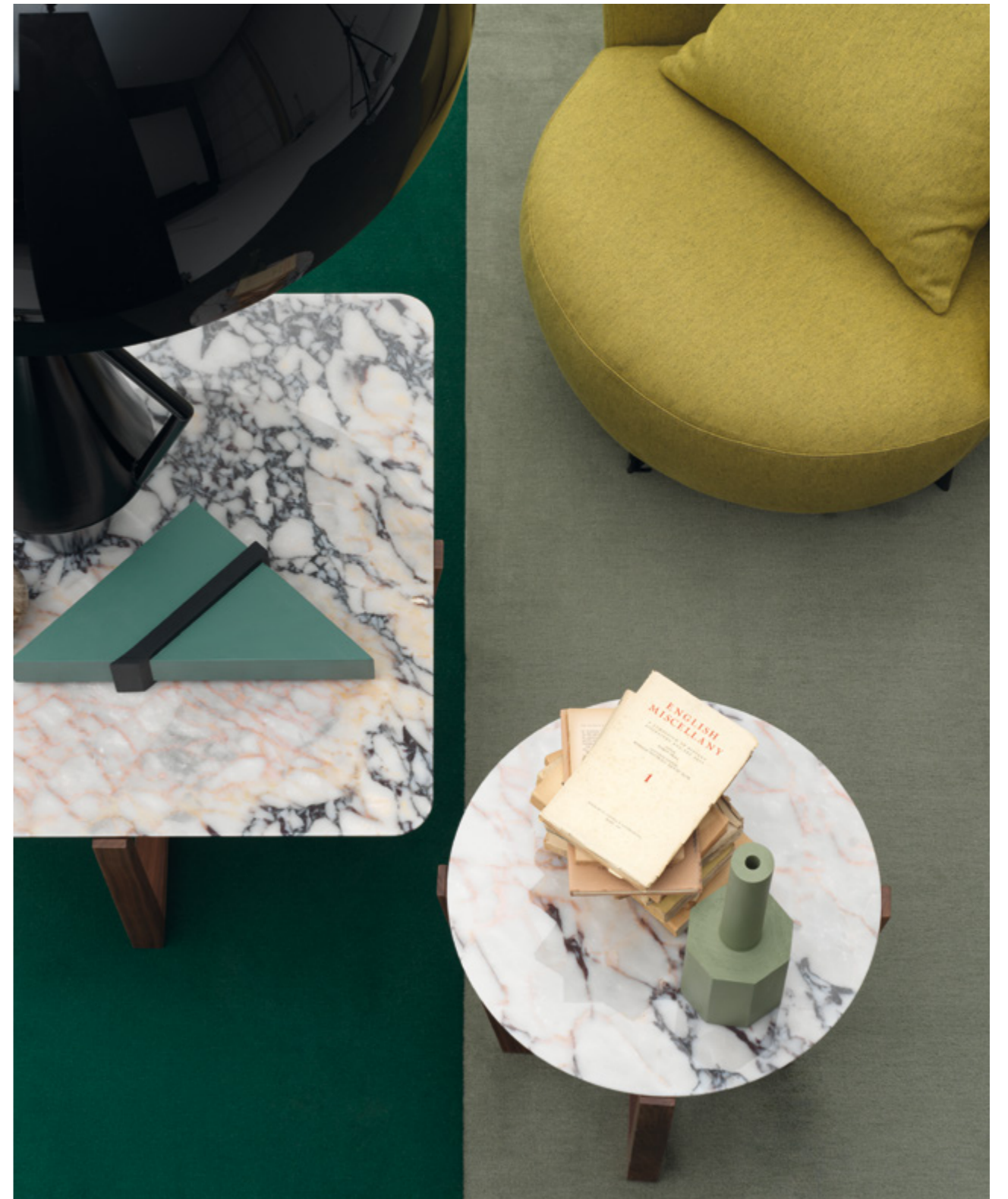





BROADWAY 2

designed by ALBERTA STYLE DEPARTMENT















THEO/THEO SLIM

designed by GOLDEN YOUNG STUDIO

















THEO SLIM





THEO

COLORI CUCITURE - STITCHING COLOURS



SUMMER

designed by ALBERTA STYLE DEPARTMENT





















HONOLULU

designed by ALBERTA STYLE DEPARTMENT





KALINDA

designed by ALBERTA STYLE DEPARTMENT





ELLE

designed by ALBERTA STYLE DEPARTMENT





GOSSIP

designed by CASTELLO LAGRAVINESE STUDIO







ALCAZAR

divano/sofa/canapé/Sofa



6 7

ALCAZAR divano/sofa/canapé/Sofa
 02ALZC1 (2ALZCHLSX+n.2 2ALZE1+2ALZPFFQ) • 8C8 Dakota Smoke, Cat. F
JIMMY 3 150x90 tavolino/small table/table/Couchtisch 150x90
 • 1JI3TAVRL • Mink Brown • struttura/structure/Struktur Gun Metal
ALBERT 1 50x50 tavolino/small table/table/Couchtisch 50x50
 • 1AL1TAVQ50 • Top marmo/marble/marbre/Marmor Arabesque Purple, Cat. X1 • struttura/structure/Struktur Noce Canaletto

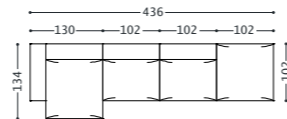

20 21

ALCAZAR divano/sofa/canapé/Sofa
 01ALZC2 (1ALZESX+n.3 1ALZE1+1ALZAR+1ALZPFFR+1ALZCHLMDX)
 • 6524 Romuald Creta, Cat. 6 - Grosgrain G63 x n.1 1ALZE1
ISLAND tavolino/small table/table/Couchtisch
 • 1ISNTSTS40 • Top Noce Canaletto • struttura/structure/Struktur Gun Metal
JIMMY 3 tavolino/small table/table/Couchtisch
 • 1JI3SER • Top Mink Brown • struttura/structure/Struktur Gun Metal

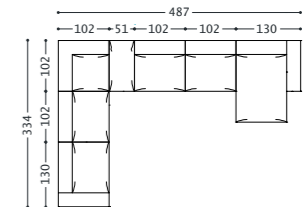

8 9

ALCAZAR divano/sofa/canapé/Sofa
 01ALZC6 (1ALZPFFQ +1ALZE1+1ALZCHLDX) • 7471 Kos 01 Ecrú, Cat. 7
SWEET JANE poltrona/armchair/fauteuil/Sessel
 • 1SWJP • C008 Delice 11 Oceano, Cat. 12 • gambe/legs/jambes/Beine French Bronze
 • 1SWJP • 511X Velvet Pavone, cat. 6 • gambe/legs/jambes/Beine French Bronze
RODEO 3 ø55 tavolino/small table/table/Couchtisch
 • 1RO3TROT5551 • Top Bordeaux • struttura/structure/Struktur Gun Metal
RODEO 5 ø90 tavolino/small table/table/Couchtisch
 • 1RO5TROT9035 • Top vetro fumé/smoked glass/verre fumé/Glas fumé • struttura/structure/Struktur Gun Metal

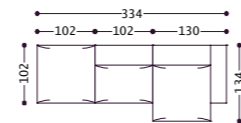

12 13

ALCAZAR divano/sofa/canapé/Sofa
 02ALZC3 (1ALZESX+1ALZPFFR+1ALZE1+1ALZCHLMDX) • 6524 Romuald Creta, Cat. 6
FRISCO 75 tavolino/small table/table/Couchtisch 75x75
 • 1FRITVQA • Top 1 marmo/marble/marbre/Marmor Calacatta White, Cat. X4 • Top 2 Mink Brown • struttura/structure/structure/Struktur Gun Metal

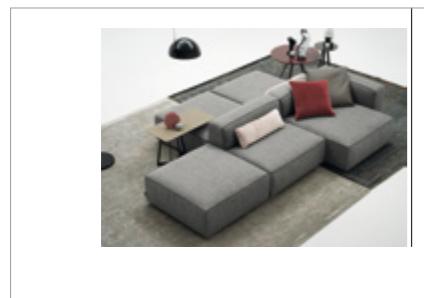
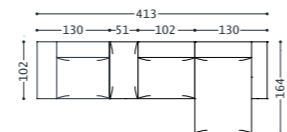

14 15

ALCAZAR divano/sofa/canapé/Sofa
 01ALZC4 (n. 3 1ALZPFFQ+1ALZE1+1ALZCHLDX) • 7635 Dolm Col. 27, Cat. 7- Grosgrain G57
JAGGER 35 tavolino/small table/table/Couchtisch ø35
 • 1JAGTH • Mink Brown
JAGGER 75 tavolino/small table/table/Couchtisch ø75
 • 1JAGTM • Bordeaux
PHIL tavolino/small table/table/Couchtisch
 • 1PHISERL • Top Dove Grey • struttura/structure/Struktur Gun Metal

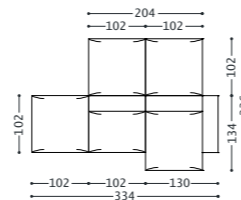

VEGA

divano/sofa/canapé/Sofa



26

27

VEGA divano/sofa/canapé/Sofa

- 1VEGD3 • 4048 Pavè Col. 622, Cat.4 • Piedini/Feet/Pieds/FüÙe in alluminio lucido/ in glossy aluminium/en aluminium brillant/aus poliertem Aluminium, h. 15 cm (PD10375)
- ISLAND tavolino/small table/table/Couchtisch
- 1ISNTLTS30 • Top Noce Canaletto • struttura/structure/Struktur Gun Metal
- ISLAND tavolino/small table/table/Couchtisch
- 1ISNTMTS23 • Top Noce Canaletto • struttura/structure/Struktur Gun Metal
- JAGGER 75 tavolino/small table/table/Couchtisch Ø75
- 1JAGTM • Dove Grey
- JAGGER 35 tavolino/small table/table/Couchtisch Ø35
- 1JAGTH • Cream

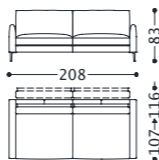

32

33

VEGA divano/sofa/canapé/Sofa

- 2VEGD3 • 8C8 Dakota Smoke, Cat.F • Piedini/Feet/Pieds/FüÙe in alluminio lucido/ in glossy aluminium/en aluminium brillant/aus poliertem Aluminium, h. 15 cm (PD10375)
- JAMMIN LARGE poltrona girevole/swivel armchair/fauteuil tournant/Drehsessel
- 1JAMPLG • 6048 Balboa Platino, Cat. 6 • basamento/base/piétement/Basis Gun Metal
- FRISCO Ø50 tavolino/small table/table/Couchtisch Ø50
- 1FRITROTL • Top 1 Mink Brown • Top 2 Mink Brown • struttura/structure/Struktur Gun Metal
- JAGGER 35 tavolino/small table/table/Couchtisch Ø35
- 1JAGTH • Cream

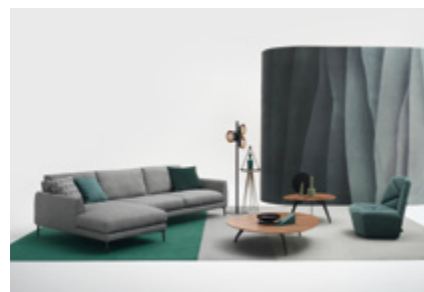
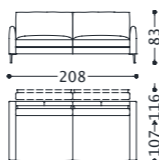

38

39

VEGA divano/sofa/canapé/Sofa

- 01VEGC1 (1VEGDORMSX + 1VEGD3DX) • 6B14 Sussurro Platino, Cat. 6 • Piedini/Feet/Pieds/FüÙe in alluminio verniciato marrone/ in in brown varnished aluminium/en aluminium verni marron/aus lackiertem braunen Aluminium, h. 15 cm (PD10376)
- GOSSIP poltrona/armchair/fauteuil/Sessel
- 1GSPP • 6C53 Zoe 1520, Cat. 6
- ISLAND tavolino/small table/table/Couchtisch
- 1ISNTLTS30 • Top Noce Canaletto • struttura/structure/Struktur Gun Metal
- ISLAND tavolino/small table/table/Couchtisch
- 1ISNTSTS40 • Top Noce Canaletto • struttura/structure/Struktur Gun Metal
- JAGGER 35 tavolino/small table/table/Couchtisch Ø35
- 1JAGTH • Dove Grey

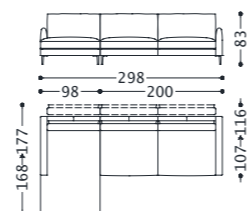

40

41

VEGA divano/sofa/canapé/Sofa

- 01VEGC2 (1VEGTRSPSX + 1VEGD3DX) • 6B14 Sussurro Platino, Cat. 6 • Piedini/Feet/Pieds/FüÙe in alluminio verniciato marrone/ in in brown varnished aluminium/en aluminium verni marron/aus lackiertem braunen Aluminium, h. 15 cm (PD10376)
- ISLAND tavolino/small table/table/Couchtisch
- 1ISNTLTS30 • Top Noce Canaletto • struttura/structure/Struktur Gun Metal
- ISLAND tavolino/small table/table/Couchtisch
- 1ISNTMTS23 • Top Noce Canaletto • struttura/structure/Struktur Gun Metal

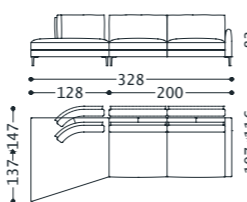

COLLINS 2

divano/sofa/canapé/Sofa

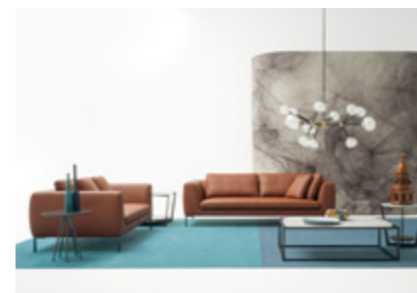

46

47

COLLINS 2 divano/sofa/canapé/Sofa

- 2CL2D3+2CL2D2 • 9N1 Ascott Marrone, Cat. G • Piedini/Feet/Pieds/FüÙe in Vernice grigio opaco/Matt grey varnish finishing/en verni gris mat/matt-Grau malen, h. 17 cm (PD10085)
- FRISCO Ø50 tavolino/small table/table/Couchtisch Ø50
- 1FRITROT • Top 1 marmo/marble/marbre/Marmor Calacatta white, Cat. X4 • Top 2 MinkBrown • struttura/structure/Struktur Gun Metal
- FRISCO 75 tavolino/small table/table/Couchtisch 75X75
- 1FRITAVQA • Top 1 marmo/marble/marbre/Marmor Calacatta white, Cat. X4 • Top 2 MinkBrown • struttura/structure/Struktur Gun Metal
- JAGGER 50 tavolino/small table/table/Couchtisch Ø50
- 1JAGTL • Mink Brown

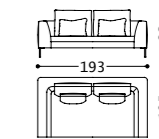
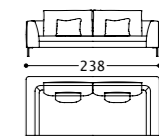

50

51

COLLINS 2 divano/sofa/canapé/Sofa

- 01CL2C1 (1CL2D3SX+1CL2CHLMDX) • 4049 Pavè Col. 016, Cat.4 • Piedini/Feet/Pieds/FüÙe in metallo cromato/Metal chromium/en métal chromé/Chrom, h. 17 cm (PD10083)
- JIMMY 3 150x90 tavolino/small table/table/Couchtisch 150x90
- 1J3TAVRL • Top Mink Brown • struttura/structure/Struktur Gun Metal
- JIMMY 3 75x75 tavolino/small table/table/Couchtisch 75X75
- 1J3TAVQ75M • Top Dove Grey • struttura/structure/Struktur Gun Metal
- JIMMY 3 tavolino/small table/table/Couchtisch
- 1J3SER • Top Mink Brown • struttura/structure/Struktur Gun Metal

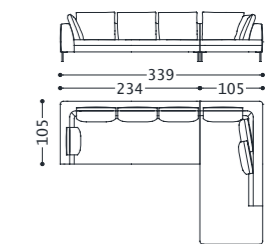

PITAGORA

divano/sofa/canapé/Sofa

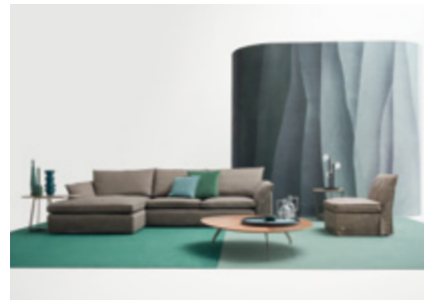

56

57

PITAGORA divano/sofa/canapé/Sofa
 • 0PTGC10 (1PTGCHLSX +1PTGD2MDX) • 6B14 Sussurro Platino, Cat. 6 • Cucitura pizzicata/double felled stitch/couture rabattue/ Näht "Pizzicata" (OPTION B)
PITAGORA poltrona/armchair/fauteuil/Sessel
 • 2PITPSP • 9K7 Columbia Gobi, Cat. F
ISLAND tavolino/small table/table/Couchtisch
 • 1ISNTLTS30 • Top Noce Canaletto • struttura/structure/Struktur French Bronze
FRISCO Ø50 tavolino/small table/table/Couchtisch Ø50
 • 1FRITROTL • Top 1 Dove Grey • Top 2 Dove Grey • struttura/structure/Struktur French Bronze
PHIL tavolino/small table/table/Couchtisch
 • 1PHISERL • Top Dove Grey • struttura/structure/Struktur Gun Metal

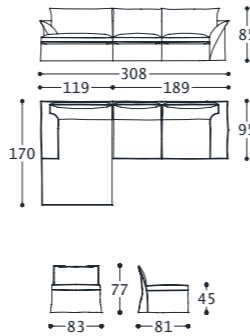

60

61

PITAGORA divano/sofa/canapé/Sofa
 • 0PITC9 (2PITCHLMSX +2PITD3DX) • 9C4 Sensation Nero, Cat. H
ALBERT1 130x80 tavolino/small table/table/Couchtisch 130x80
 • 1AL1TAVR • Top marmo/marble/marbre/Marmor Marquina Black, Cat. X2 • struttura/structure/Struktur Noce Canaletto
ALBERT1 Ø50 tavolino/small table/table/Couchtisch Ø50
 • 1AL1TROT50 • Top marmo/marble/marbre/Marmor Marquina Black, Cat. X2 • struttura/structure/Struktur Noce Canaletto
JIMMY 3 tavolino/small table/table/Couchtisch
 • 1JI3SER • Top Dove Grey • struttura/structure/Struktur Gun Metal

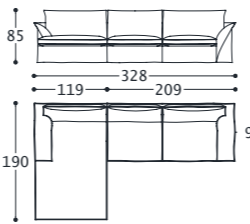

64

65

PITAGORA divano/sofa/canapé/Sofa
 • 1PTGD3 • 6521 Romuald avorio, Cat. 6 • Bordone/big piping/ passepoil gros/grosse Bordüre (OPTION A)
PITAGORA pouff/pouf/Hocker
 • 1PTGPFQ • 511Y Velvet topo, Cat. 6 • Bordone/big piping/ passepoil gros/grosse Bordüre (OPTION A)
JIMMY 3 tavolino/small table/table/Couchtisch
 • 1JI3SER • Top Burgundy • struttura/structure/Struktur Gun Metal
JIMMY 3 55x55 tavolino/small table/table/Couchtisch 55x55
 • 1JI3TAVQ55H • Top Burgundy • struttura/structure/Struktur Gun Metal
JAGGER 35 tavolino/small table/table/Couchtisch ø 35
 • 1JAGTH • Dove Grey

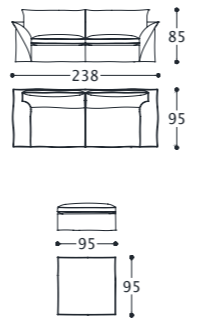

68

69

PITAGORA divano/sofa/canapé/Sofa
 • 0PITC1 (2PITD3SX+2PITD3DX) • 9C4 Sensation Nero, Cat. H

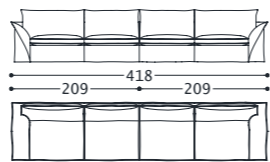

MANHATTAN 2

divano/sofa/canapé/Sofa



72

73

MANHATTAN 2 divano/sofa/canapé/Sofa
 • 02MN2C1 (1MN2D2MSX+1MN2DORMDX+1MN2PTD2M) • 9N1 Ascott Marrone, Cat. G • Piedini/Feet/Pieds/Füße in ABS, h. 4 cm (PD650)
FRISCO 130X80 tavolino/small table/table/Couchtisch 130X80
 • 1FRITAVR • Top 1 marmo/marble/marbre/Marmor Cream Calacatta, Cat. X4 • Top 2 Mink Brown • struttura/structure/Struktur Gun Metal
PHIL tavolino/small table/table/Couchtisch
 • 1PHISER • Top marmo/marble/marbre/Marmor Cream Calacatta, Cat. X4 • struttura/structure/Struktur Gun Metal

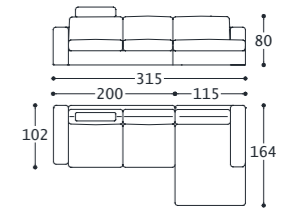

76

77

MANHATTAN 2 divano/sofa/canapé/Sofa
 • 2MN2D3M • 8C9 Dakota Antracite, Cat. F • Piedini/Feet/Pieds/Füße in ABS, h. 4 cm (PD650)
JAMMIN LARGE poltrona girevole/swivel armchair/fauteuil tournant/Drehsessel
 • 1JAMPLG • 8475 Creta 36, Cat. 7 • basamento/base/piétement/Basis Gun Metal
ALBERT1 130x80 tavolino/small table/table/Couchtisch 130x80
 • 1AL1TAVR • Top marmo/marble/marbre/Marmor Arabesque Purple, Cat. X1 • struttura/structure/Struktur Noce Canaletto
ALBERT1 75x75 tavolino/small table/table/Couchtisch 75X75
 • 1AL1TAVQ75 • Top marmo/marble/marbre/Marmor Arabesque Purple, Cat. X1 • struttura/structure/Struktur Noce Canaletto
ALBERT1 Ø50 tavolino/small table/table/Couchtisch Ø50
 • 1AL1TROT50 • Top marmo/marble/marbre/Marmor Arabesque Purple, Cat. X1 • struttura/structure/Struktur Noce Canaletto

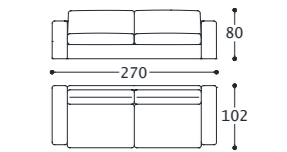

82

83

MANHATTAN 2 divano/sofa/canapé/Sofa
 • 02MN2C2 (1MN2D2MSX+1MN2J1+1MN2PDX) • 7637 Dolm Col.26, Cat. 7 • Piedini/Feet/Pieds/Füße in ABS, h. 4 cm (PD650)
JAGGER 50 tavolino/small table/table/Couchtisch Ø50
 • 1JAGTL • Mink Brown
JAGGER 75 tavolino/small table/table/Couchtisch Ø75
 • 1JAGTM • Mink Brown
JAGGER 35 tavolino/small table/table/Couchtisch Ø35
 • 1JAGTH • Mink Brown

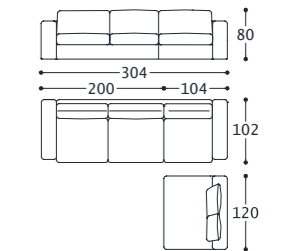

BROADWAY 2

divano/sofa/canapé/Sofa



88

89

- BROADWAY 2** divano/sofa/canapé/Sofa
 • 01BD2C9 (1BD2MERSX+1BD2D3MDX) • 6B14 Sussurro Platino, Cat. 6 • Piedini/Feet/Pieds/Füße in ABS, h. 4 cm (PD650)
GOSSIP poltrona/armchair/fauteuil/Sessel
 • 1GSPP
JIMMY 3 55x55 tavolino/small table/table/Couchtisch 55X55
 • 1JI3TAVQ55M • Dove Grey • struttura/structure/Struktur Gun Metal
JIMMY 3 tavolino/small table/table/Couchtisch
 • 1JI3SER • Top Mink Brown • struttura/structure/Struktur Gun Metal

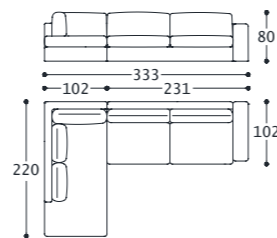

90

91

- BROADWAY 2** divano/sofa/canapé/Sofa
 • 01BD2C8 (1BD2D2SX+1BD2TRDX) • 7636 Dolm Col. 42, Cat. 7 • Piedini/Feet/Pieds/Füße in ABS, h. 4 cm (PD650)
ALBERT1 130x80 tavolino/small table/table/Couchtisch 130x80
 • 1AL1TAVR • Top marmo/marble/marbre/Marmor Arabesque Purple, Cat. X1 • struttura/structure/Struktur Noce Canaletto
ALBERT1 Ø50 tavolino/small table/table/Couchtisch Ø50
 • 1AL1TROT50 • Top marmo/marble/marbre/Marmor Arabesque Purple, Cat. X1 • struttura/structure/Struktur Noce Canaletto
JAGGER 35 tavolino/small table/table/Couchtisch Ø35
 • 1JAGTH • Mink Brown
JAGGER 75 tavolino/small table/table/Couchtisch Ø75
 • 1JAGTM • Dove Grey

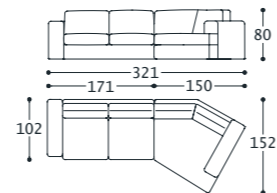

94

95

- BROADWAY 2** divano/sofa/canapé/Sofa
 • 1BD2D3MSPP+1BD2P • 4385 Newsun Lightgrey 06, Cat. 4 • Piedini/Feet/Pieds/Füße in ABS, h. 4 cm (PD650)
FRISCO 75 tavolino/small table/table/Couchtisch 75X75
 • 1FRITAVQA • Top 1 marmo/marble/marbre/Marmor Marquina Black, Cat. X2 • Top 2 Mink Brown • struttura/structure/Struktur Gun Metal
FRISCO Ø50 tavolino/small table/table/Couchtisch Ø50
 • 1FRITROT • Top 1 marmo/marble/marbre/Marmor Marquina Black, Cat. X2 • Top 2 Mink Brown • struttura/structure/Struktur Gun Metal

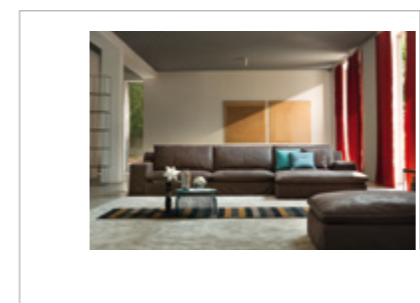
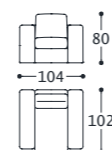
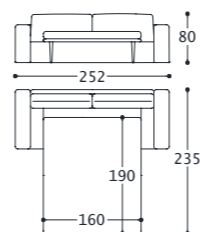

102

103

- THEO** divano/sofa/canapé/Sofa
 • 0THOC3 (2THOD3MSX+2THODORMDX) • 9C3 Sensation T.Moro, Cat. H • Cucitura punto cavallo Cod. 35835 Grigio/Saddle stitching Cod. 35835 Grey/Couture Cavallo Kod. 35835 Grau
THEO pouff/pouf/Hocker
 • 2THOPFFQ • 9C3 Sensation T.Moro, Cat. H • Cucitura punto cavallo Cod. 35835 Grigio/Saddle stitching Cod. 35835 Grey/Couture selliers Cod. 35835 Gris/Näht "Punto Cavallo Kod. 35835 Grau"

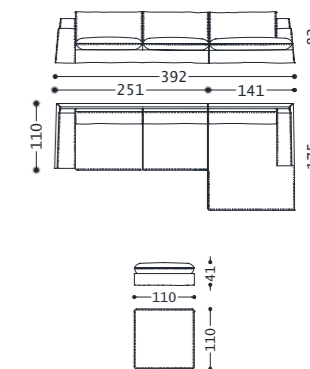

106

107

- THEO** divano/sofa/canapé/Sofa
 • 2THOD3M • 9C3 Sensation T.Moro, Cat. H • Cucitura punto cavallo Cod. 35835 Grigio/Saddle stitching Cod. 35835 Grey/Couture selliers Cod. 35835 Gris/Näht "Punto Cavallo Kod. 35835 Grau"

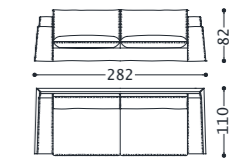

108

109

- THEO** divano/sofa/canapé/Sofa
 • 2THOD3M • 954 Fjord Sand, Cat. G • Cucitura punto cavallo Cod. 790 Testa Moro/Saddle stitching Cod. 790 Dark Brown/Couture selliers Cod. 790 marron foncé/Näht "Punto Cavallo Kod. 790 Dunkelbraun"



110

111

- THEO** divano/sofa/canapé/Sofa
 • 0TETC4 (1TETD3MSX + 1TETMERDX) • 7960 Petalo 16 Tortora, Cat. 7

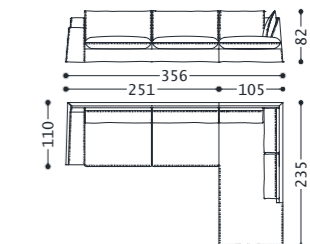

THEO SLIM

divano/sofa/canapé/Sofa



114

115

THEO SLIM divano/sofa/canapé/Sofa
 • 2THSD3EP • 9G4 Nabuk seppia, Cat. 1 • Cucitura punto cavallo Cod. 35767 Marrone/Saddle stitching Cod. 35767 Brown/Couture selliers Cod. 35767 marron/Näht "Punto Cavallo Kod. 35767 Braun"

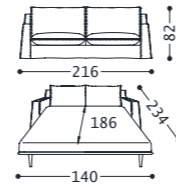

120

121

SUMMER divano/sofa/canapé/Sofa
 • C1STSM (D2LSXSTSM+DORMDXSM) • 4051 Pavè Col. 027, Cat. 4
 • GOSSIP poltrona/armchair/fauteuil/Sessel • 2GSPP
 • ALBERT1 Ø50 tavolino/small table/table/Couchtisch Ø50
 • 1AL1TROT50 • Top marmo/marble/marbre/Marmor Verde Issoire, Cat. X4 • struttura/structure/Struktur Noce Canaletto
 • ALBERT1 50X50 tavolino/small table/table/Couchtisch 50X50
 • 1AL1AVQ50 • Top marmo/marble/marbre/Marmor Verde Issoire, Cat. X4 • struttura/structure/Struktur Noce Canaletto
 • JAMMIN pouff/pouf/Hocker
 • 1JAMPOUFF • 820N Real E37, Cat. 8
 • ISLAND tavolino/small table/table/Couchtisch
 • 1ISNTLTS30 • Top Noce Canaletto • struttura/structure/Struktur Gun Metal
 • ISLAND tavolino/small table/table/Couchtisch
 • 1ISNTSTS40 • Top Noce Canaletto • struttura/structure/Struktur Gun Metal

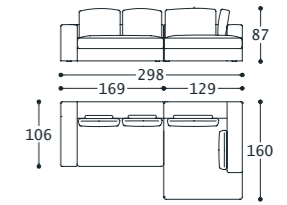

122

123

SUMMER DEEP divano/sofa/canapé/Sofa
 • 1SMMD3MPR • 7247 Superlino Grisaglia, Cat. 7

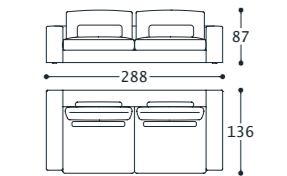

126

127

SUMMER divano/sofa/canapé/Sofa
 • 0SMMC18 (D2MSXSTSM+MERDXSM) • 7249 Superlino Terra, Cat. 7

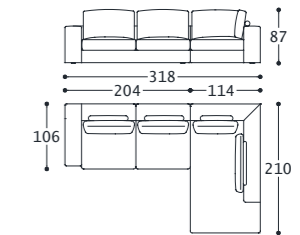

128

129

SUMMER DEEP divano/sofa/canapé/Sofa
 • 0SMMC12 (1SMMPFQPR+1SMMP LPR1+1SMMARPRDX +D3DXSTSM) • 8464 Creta 54, Cat. 7

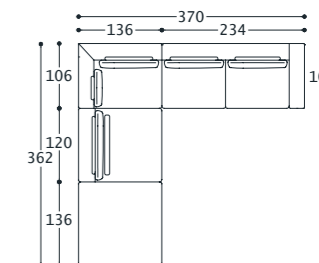

SUMMER

divano/sofa/canapé/Sofa



130

131

SUMMER divano/sofa/canapé/Sofa
• C1STSMM (D2LSXSTSMM+DORMDXSMM) • 8313 Creta 65 Bianco, Cat. 7

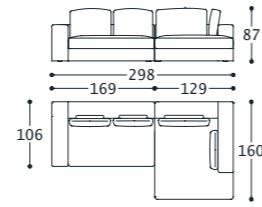

132

133

SUMMER divano/sofa/canapé/Sofa
• D3MSTSMM • 8462 Creta 06, Cat. 7



134

135

SUMMER divano/sofa/canapé/Sofa
• 2SMRD2LSX-2SMRD2LJDX • 954 Fjord Sand, Cat. G
SUMMER DEEP divano/sofa/canapé/Sofa
• 2SMRD3MPR • 954 Fjord Sand, Cat. G

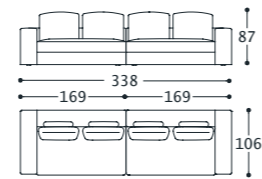

136

137

SUMMER divano/sofa/canapé/Sofa
• 2SMRD3M • 9N1 Ascott Marrone, Cat. G

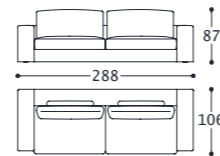

HONOLULU

poltrona relax/relax armchair/fauteuil relax/Sessel relax

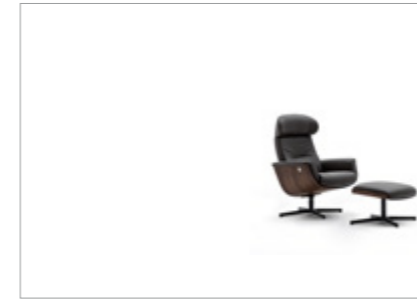

139

HONOLULU poltrona relax/relax armchair/fauteuil relax/Sessel relax
• 02HONC3 (2HONPAGNONV+ 2HONPOUFFNONV) • 517 Sahara Testa Moro, Cat. E • struttura esterna noce/surface walnut/Structure extérieure noyer/Aussenstruktur Nussbaum • basamento nero verniciato/base varnished black/piètement noire vernie/Basis aus Schwarz lackiert

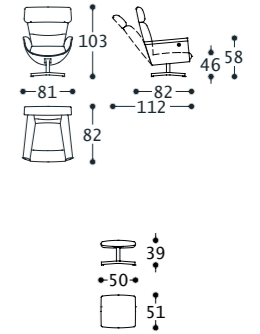

KALINDA

chaise longue/Liege



143

KALINDA chaise longue girevole/swivel chaise longue/chaise longue tournante/Dreh-Liege
• C1KLT (CHLGKLT+PTKLT) • 6527 Romuald Platino, Cat. 6
• Basamento girevole cromato/Chromed metal swivel Base/
Piètement tournant en métal chromé/ Drehbasis aus Verchromtem Metall

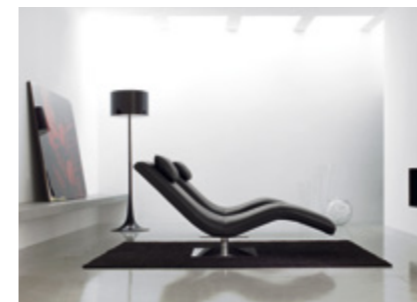
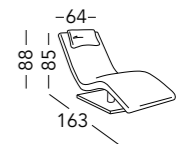

144

145

KALINDA chaise longue girevole/swivel chaise longue/chaise longue tournante/Dreh-Liege
• C1PKLD (CHLGPKLD+PTPKLD) • 518 Sahara Nero, Cat. E
• Basamento girevole cromato/Chromed metal swivel Base/
Piètement tournant en métal chromé/ Drehbasis aus Verchromtem Metall

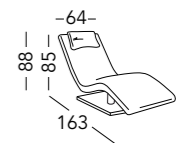

ELLE

poltrona/armchair/fauteuil/Sessel

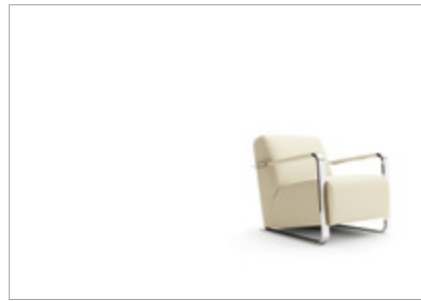

147

ELLE poltrona/armchair/fauteuil/Sessel
 • PMPELL • 9N3 Ascott Ghiaccio, Cat. G • Basamento e braccioli in metallo cromato/Base and arms in chromed metal/Piètement et accoudoirs en métal chromé/Basis und Armlehne aus Verchromtem Metall

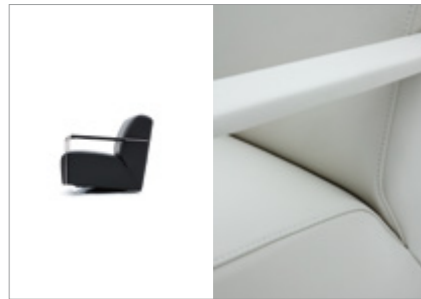
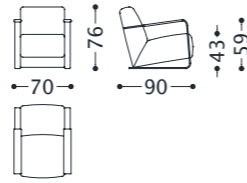

148



149

ELLE poltrona girevole/swivel armchair/fauteuil tournant/Drehsessel
 • PMGRPELL • 9N9 Ascott Black, Cat. G • Basamento girevole e braccioli in metallo cromato/Swivel Base and arms in chromed metal/Piètement tournant et accoudoirs en métal chromé/Basis und Armlehne aus Verchromtem Metall

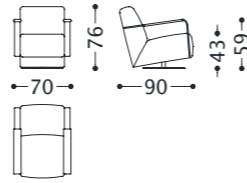

GOSSIP

poltrona/armchair/fauteuil/Sessel

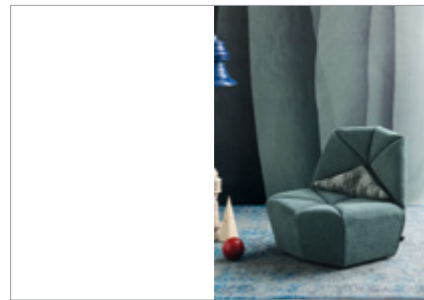

151

GOSSIP poltrona/armchair/fauteuil/Sessel
 • 01GSPC1 (1GSPP+1GSPCP72) • 6C53 Zoe 1520, Cat. 6 (1GSPP)

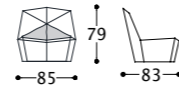

MARMO/MARBLE/MARBRE/MARMOR



Magic Brown • Cat. X1



Arabesque purple • Cat. X1



Daino Reale • Cat. X2



Calacatta White • Cat. X4

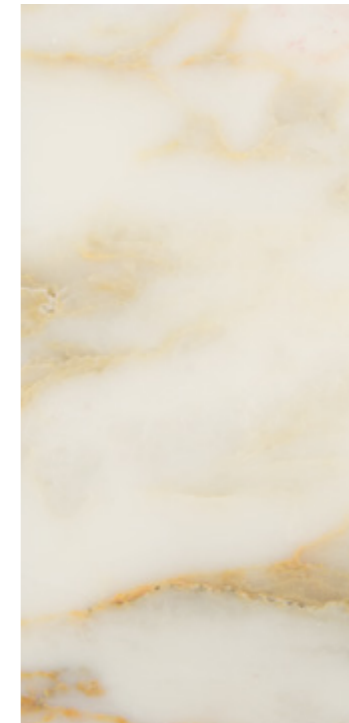

Cream Calacatta • Cat. X4

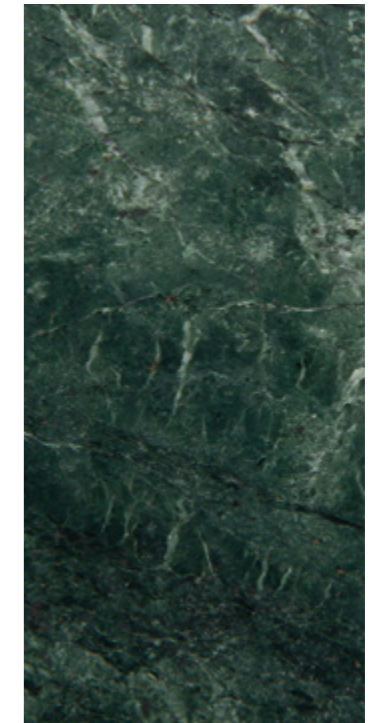

Verde Issorie • Cat. X4

MARMO/MARBLE/MARBRE/MARMOR



Marquina black • Cat. X2

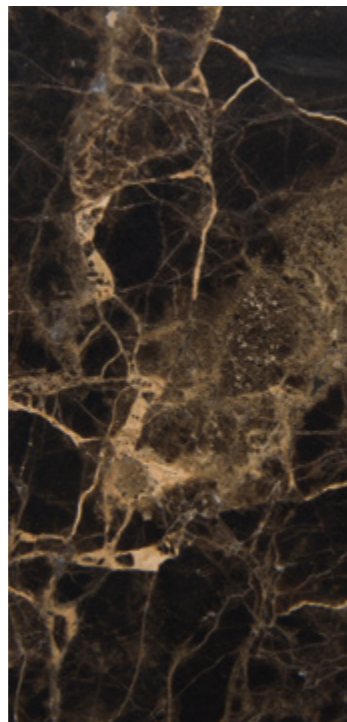

Emperador Brown • Cat. X3



Natural Travertino • Cat. X3

CERAMICA/CERAMIC/CÉRAMIQUE/KERAMIK



Calacatta White

METALLO/METAL/MÉTAL/METALL



Gun Metal

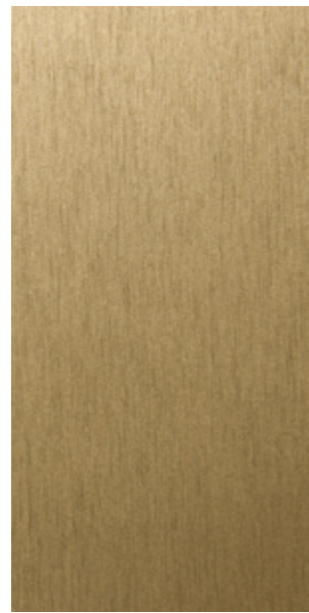

French Bronze

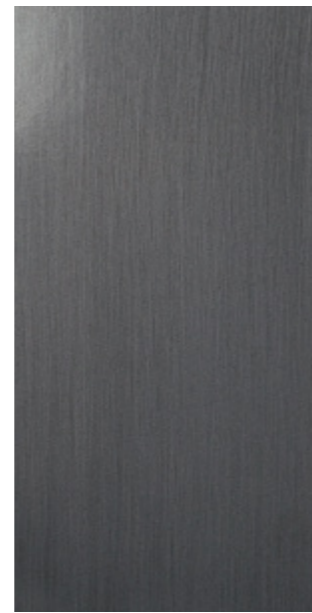

Glossy Browned

LEGNO/WOOD/BOIS/HOLZ

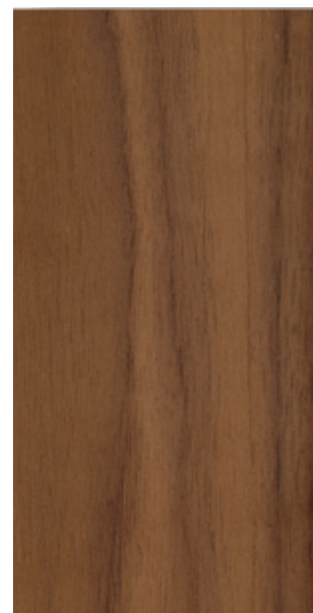

Noce Canaletto / Canaletto Walnut



Rovere Scuro / Dark Oak

LACCATI/LACQUERED/LAQUÉS/LACKIERT

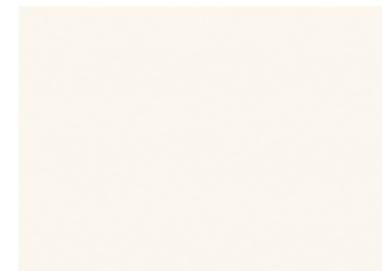

Ivory

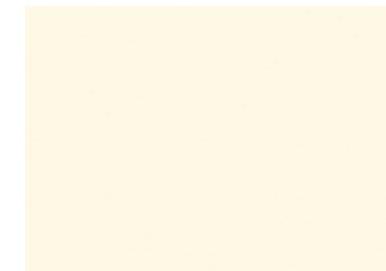

Cream

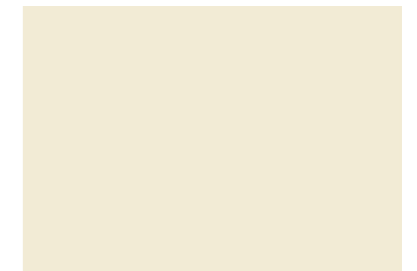

Snow



Mist



Grey



Dove Grey



Mink Brown

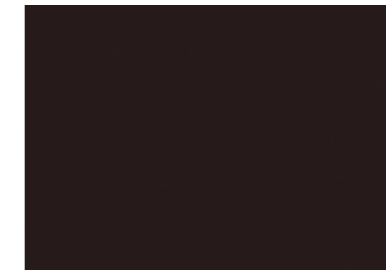

Dark brown

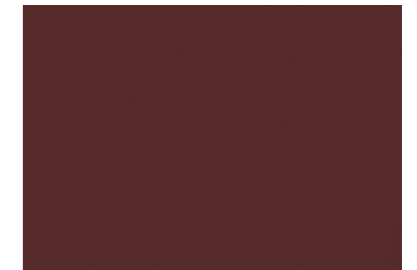

Bordeaux



Rust

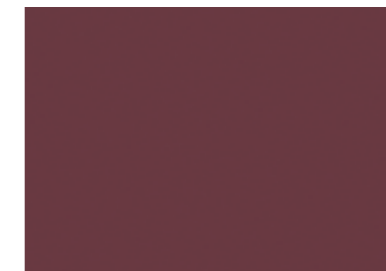

Burgundy



Green



Blue

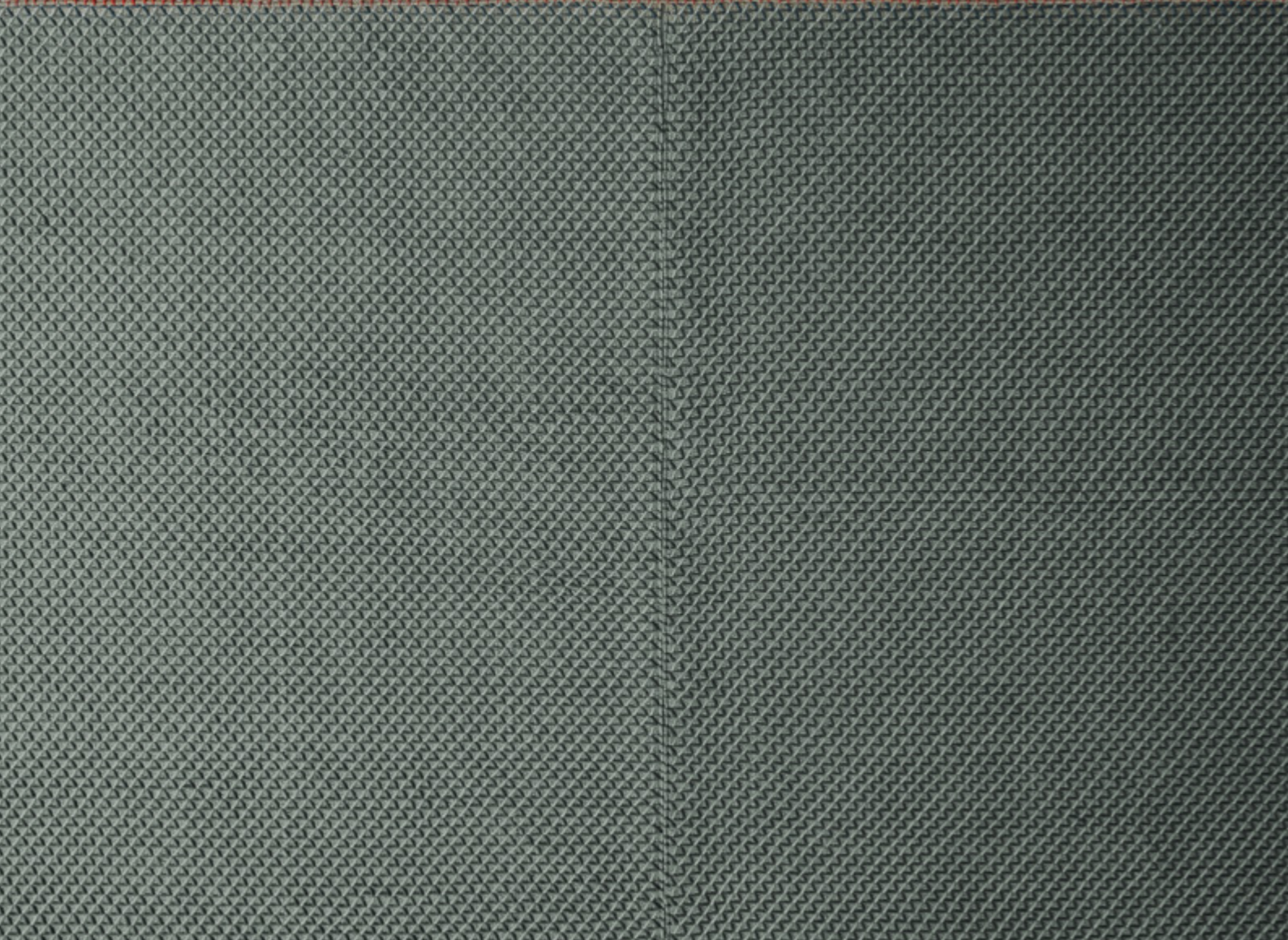
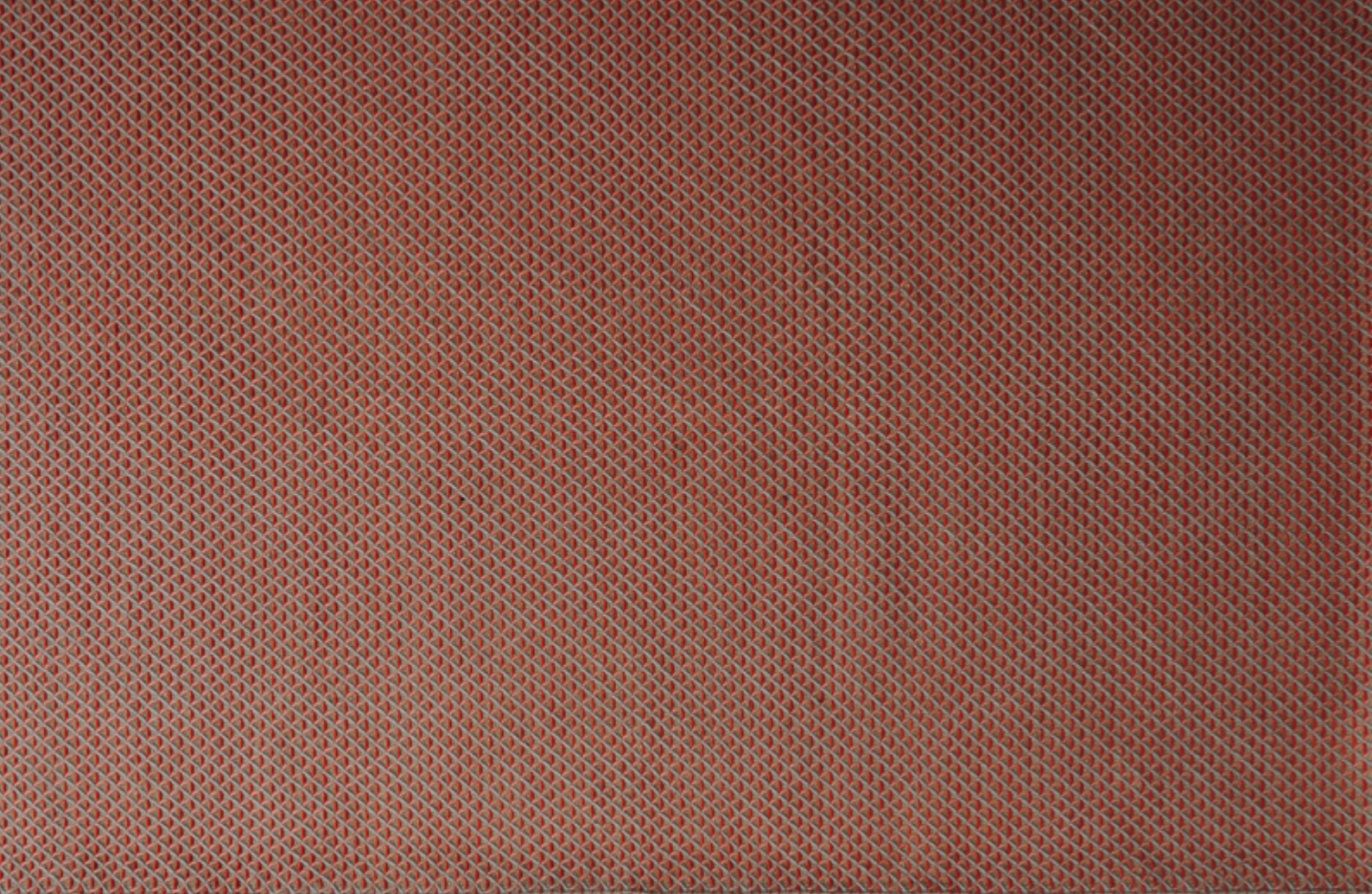

ALCAZAR

divano/sofa/canapé/Sofa

designed by Alberta Style Department



Struttura portante: Multistrato, massello di legno.
Imbottiture: Schienale in poliuretano espanso (densità 25 kg/mc) rivestito in resinato accoppiato a cotone. Cuscino di seduta in poliuretano espanso (densità 35 kg/mc) rivestito in tela cotone con imbottitura in piuma e fibra di poliestere. Scocca in poliuretano espanso a densità differenziata rivestita in resinato accoppiato a cotone.
Molleggio: Cinghie elastiche in polipropilene e gomma.
Piedino: ABS, 4 cm.

Main structure: Solid wood.
Upholstery: Backrest cushion in polyurethane foam (density 25 kg/mc) covered with resinate coupled with cotton. Seat cushion in polyurethane foam (density 35 kg/mc) covered with cotton fabric with padding in goose feather and polyester fiber. Chassis in polyurethane foam with different densities covered with resinate coupled with cotton.
Suspensions: Elastic belts in polypropylen and rubber.
Feet: ABS, 4 cm.

Structure: Multiplis et bois massif.
Rembourrage: Coussin de dossier en mousse de polyuréthane (densité 25 Kg/mc) revêtu de résine accouplé avec coton. Coussin d'assise en mousse de polyuréthane (densité 35 Kg/mc) revêtu en housse de coton avec du rembourrage en plumes et fibre de polyester. Chassis en mousse de polyuréthane à densités différentes revêtu de résine accouplé avec coton.
Suspension: Sangles élastiques en polypropylène et mousse.
Pieds: en ABS, 4 cm.

Hauptstruktur: vielschichtiges Massivholz.
Polsterung: Rückenlehne aus Polyurethaschaum (Dichte 25 kg/mc) mit Resinat aus gekoppelten Baumwollen bedeckt. Sitzkissen aus Polyurethaschaum (Dichte 35 kg/mc), mit Baumwollstoffe bedeckt und Polsterung aus Gänsedaunen und Polyesterfaser. Chassis aus Polyurethaschaum unterschiedlicher Dichte mit verkoppelte Resinat und Samt bedeckt.
Federung: Elastische Gurte aus Gummi und Polypropylen.
FüÙe: ABS, 4 cm.

Cod. Tessuto/fabric/tissu/Stoff: 1/01
 Cod. Pelle/leather/cuir/Leder: 2/02

ELEMENTI/ELEMENTS/ÉLÉMENTS/ELEMENTE

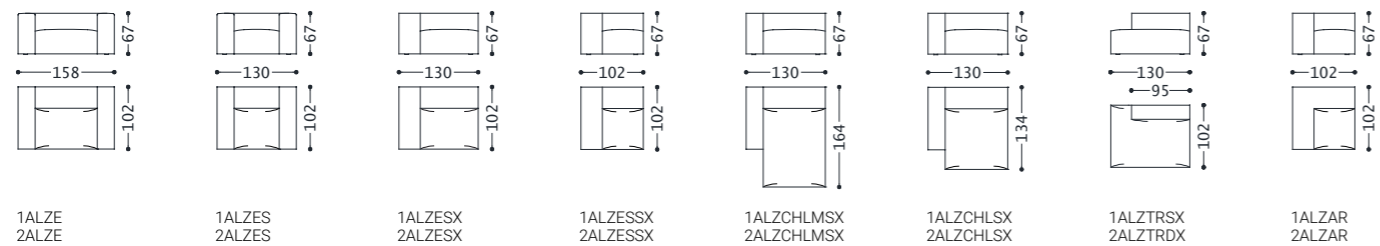
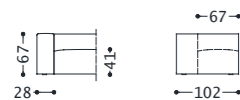

ALCAZAR

divano/sofa/canapé/Sofa

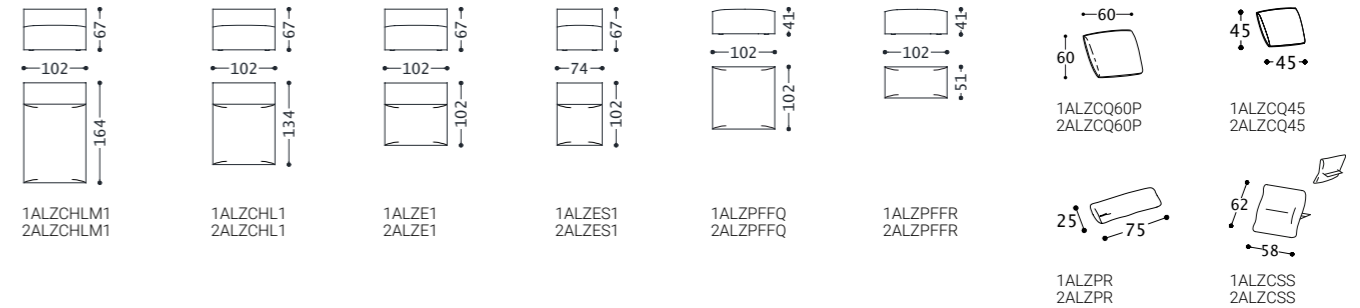

COMPOSIZIONI/COMPOSITIONS/KOMPOSITIONEN

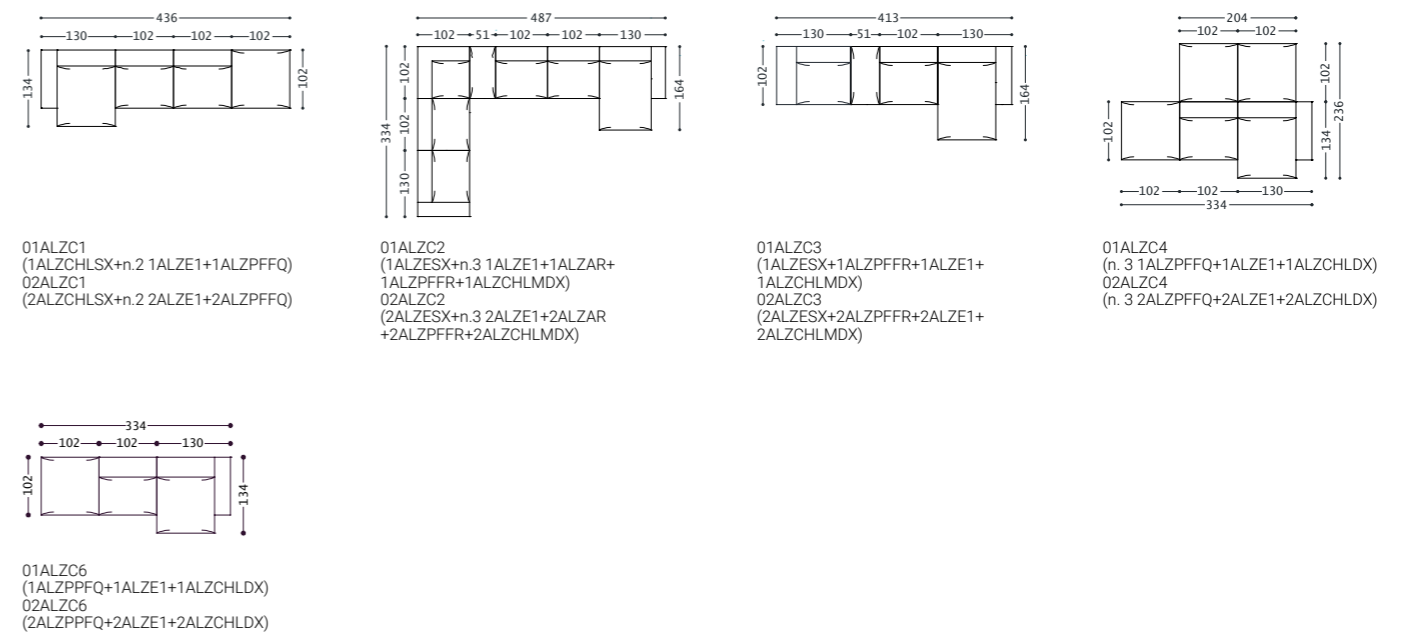

VEGA

divano/sofa/canapé/Sofa

designed by Alberta Style Department



Struttura portante: Multistrato, massello di legno. Meccanismo schienale in metallo.
Imbottitura: Cuscino di schienale in piuma d'oca e fibra di poliestere rivestito in tela di cotone/poliestere. Cuscino di seduta in poliuretano espanso a densità differenziata, rivestito in falda termolegata. Scocca in poliuretano espanso (densità 30 kg/mc) rivestita in resinato accoppiato a vellutino.
Molle: Cinghie elastiche in polipropilene e gomma.
Piedino standard: in alluminio lucido, h. 15 cm (Cod. PD10375).
Piedino optional: in alluminio verniciato marrone, h. 15 cm (Cod. PD10376).

Main structure: Solid wood. Metal mechanism of the backrest.
Upholstery: Backrest cushion in goose feathers and polyester fiber covered with cotton/polyester fabric. Seat cushion in polyurethane foam with different densities, covered with heat-boned layer. Chassis in polyurethane foam (density 30 kg/mc) covered with resinate coupled with velvet.
Suspensions: Elastic belts in polypropylen and rubber.
Standard feet: in glossy aluminium, h. 15 cms (Cod. PD10375).
Optional feet: in brown varnished aluminium, h. 15 cms (Cod. PD10376)

Structure: Multiplis et bois massif. Mécanisme de dossier en métal.
Rembourrage: Coussin de dossier en plume d'oie et fibre de polyester sous housse de coton/polyester. Assise en mousse de polyuréthane à densités différentes revêtue en fibre thermoliée. Chassis en mousse de polyuréthane (densité 30 kg/mc) revêtue de résine accouplé avec velveteen.
Suspension: Sangles élastiques en polypropylène et mousse.
Pieds standard: en aluminium brillant, h. 15 cm (Cod. PD10375).
Pieds optionnels: en aluminium verni marron, h. 15 cm (Cod. PD10376).

Hauptstruktur: vielschichtiges Massivholz. Metal Rückenmechanismus.
Polsterung: Rückenkissen aus Gänsedaunen und Polyesterfaser mit Baumwoll/Polyester bezug verkleidet. Sitz aus Polyurethanschaum mit unterschiedlicher Dichte mit heiss geklebter Abdeckung. Chassis aus Polyurethanschaum (Dichte 30 Kg/mc) mit gekoppeltem Samt und Resinat verkleidet.
Federung: Elastische Gurte aus Gummi und Polypropylen.
Standard Füße: aus poliertem Aluminium, h. 15 cm (Kod. PD10375).
Optional Füße: aus lackiertem braunen Aluminium, h. 15 cm (Kod. PD10376)

Cod. Tessuto/fabric/tissu/Stoff: 1/01
 Cod. Pelle/leather/cuir/Leder: 2/02

PIEDINI/FEET/PIEDS/FÜßE



PD10375
(standard)



PD10376
(optional)

ELEMENTI/ELEMENTS/ÉLÉMENTS/ELEMENTE

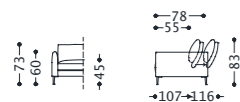

VEGA

divano/sofa/canapé/Sofa

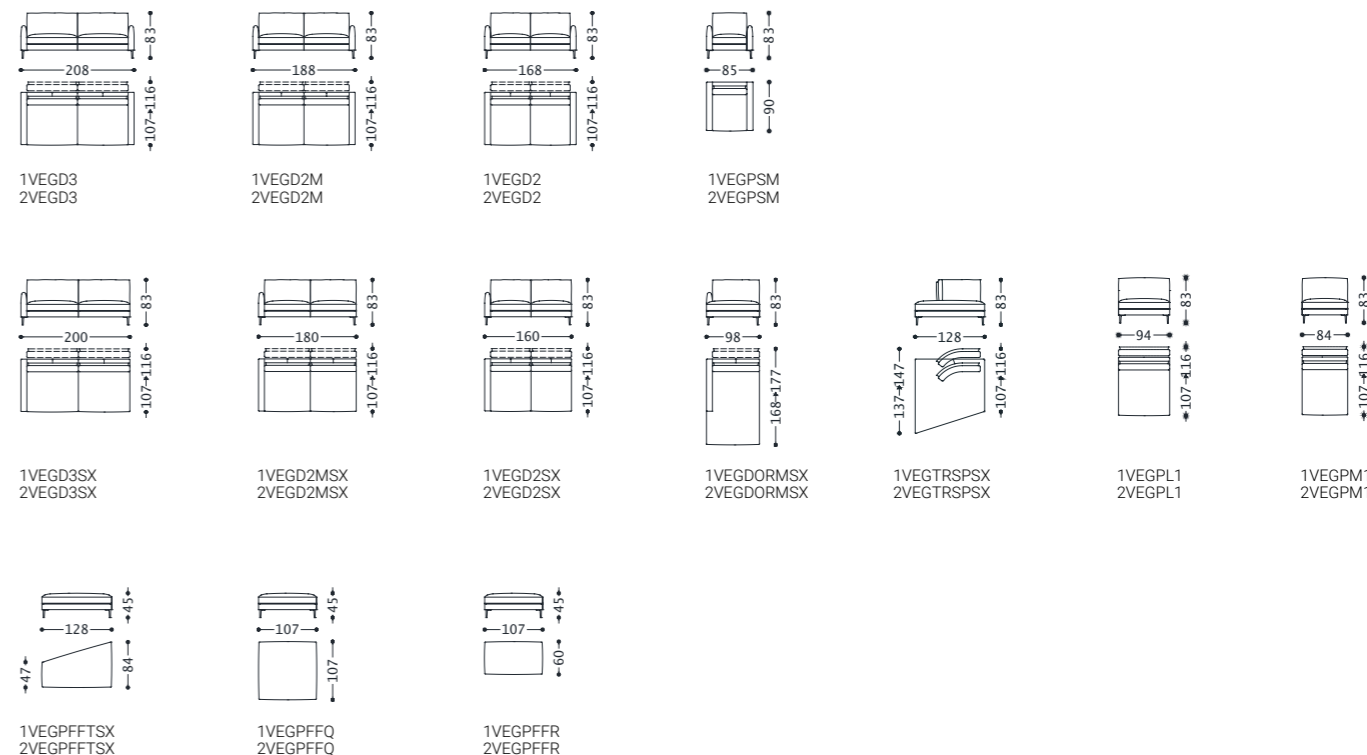

COMPOSIZIONI/COMPOSITIONS/KOMPOSITIONEN

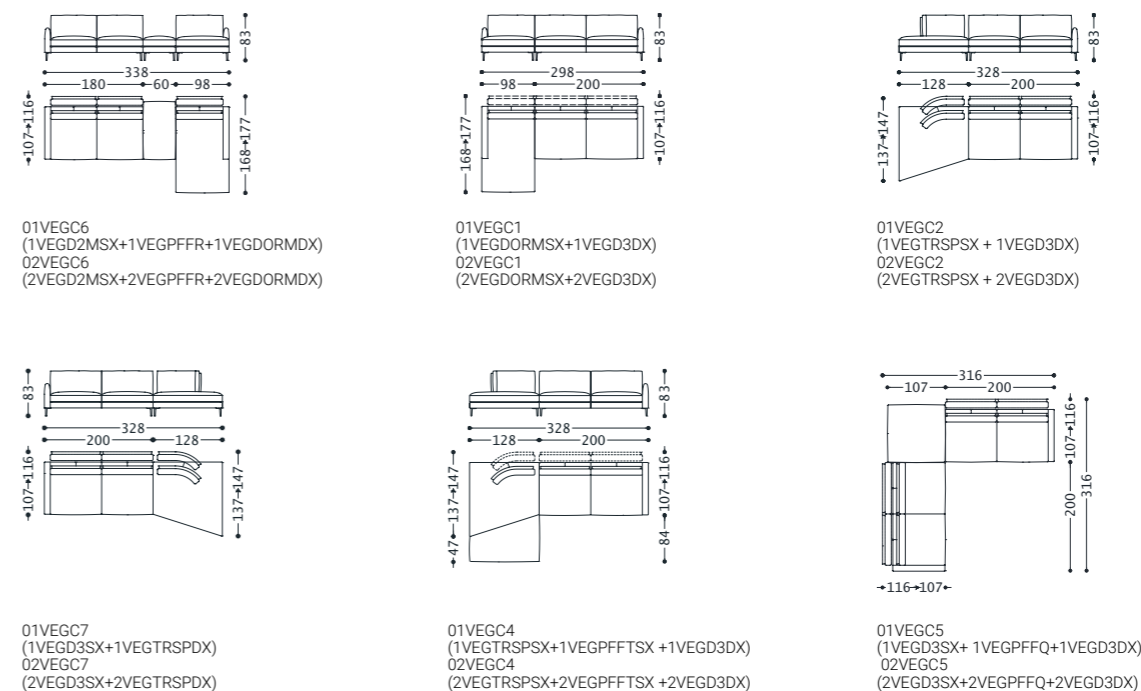

COLLINS 2

divano/sofa/canapé/Sofa

designed by Alberta Style Department



Struttura: multistrato, massello di legno.
Imbottiture: cuscini di schienale in piuma d'oca e fibra di poliestere rivestiti in tela di cotone/ poliestere; seduta in poliuretano espanso (densità 35 kg/mc) rivestita in fibra di poliestere resinata; scocca in poliuretano espanso (densità 40 kg/mc), rivestita in fibra di poliestere resinata.
Molleggio: cinghie elastiche in polipropilene e gomma.
Piedino standard: in metallo cromato, h. 17 cm (Cod. PD10083).
Piedino optional: in vernice grigio-opaco, h. 17 cm (Cod. PD10085).

Main structure: Solid wood.
Upholstery: back cushions in goose feather and polyester fiber covered with cotton/polyester fabric; seat in polyurethane foam (density 35 kg/mc), covered with polyester resin treated fiber; chassis in polyurethane foam (density 40 kg/mc), covered with polyester resin treated fiber.
Suspensions: elastic belts in polypropylene and rubber.
Standard feet: chromium plated metal feet, h. 17 cm (Cod. PD10083).
Optional feet: matt grey varnish finishing, h. 17 cms (Cod. PD10085).

Structure: multiplis et bois massif.
Rembourrage: Coussins dossier en en plume d'oie et fibre de polyester sous housse de coton/polyester; assise en mousse de polyuréthane (densité 35 kg / mc) recouvert de fibre de polyester résinée; chassis en mousse de polyuréthane (densité 40 kg / mc), recouvert de fibre de polyester résinée.
Suspension: sangles élastiques en polypropylène et mousse.
Pieds standard: en metal chromé, h. 17 cm (Cod. PD10083).
Pieds optionnels: en verni gris mat, h. 17 cm (Cod. PD10085).

Hauptstruktur: vielschichtiges Massivholz.
Polsterung: Rückenkissen aus Gänsedaunen und Polyesterfaser in Baumwolle/Polyesterstoff überzogen; Sitz aus Polyurethanschaum (Dichte 35 kg/mc) mit Kunstfaser Polyesterharz überzogen; Chassis aus Polyurethanschaum (Dichte 40 kg / mc) mit Kunstfaser Polyesterharz überzogen.
Federung: elastischen Gurten aus Polypropylen und Gummi.
Standard Füße: Metall verchromt, h. 17 cm (Kod. PD10083).
Optional Füße: Matt-Gräu Lackierung, h. 17 cm (Kod. PD10085).

Cod. Tessuto/fabric/tissu/Stoff: 1/01
 Cod. Pelle/leather/cuir/Leder: 2/02

PIEDINI/FEET/PIEDS/FÜßE



PD10083
(standard)



PD10085
(optional)

ELEMENTI/ELEMENTS/ÉLÉMENTS/ELEMENTE

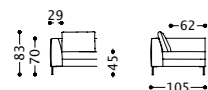

COLLINS 2

divano/sofa/canapé/Sofa

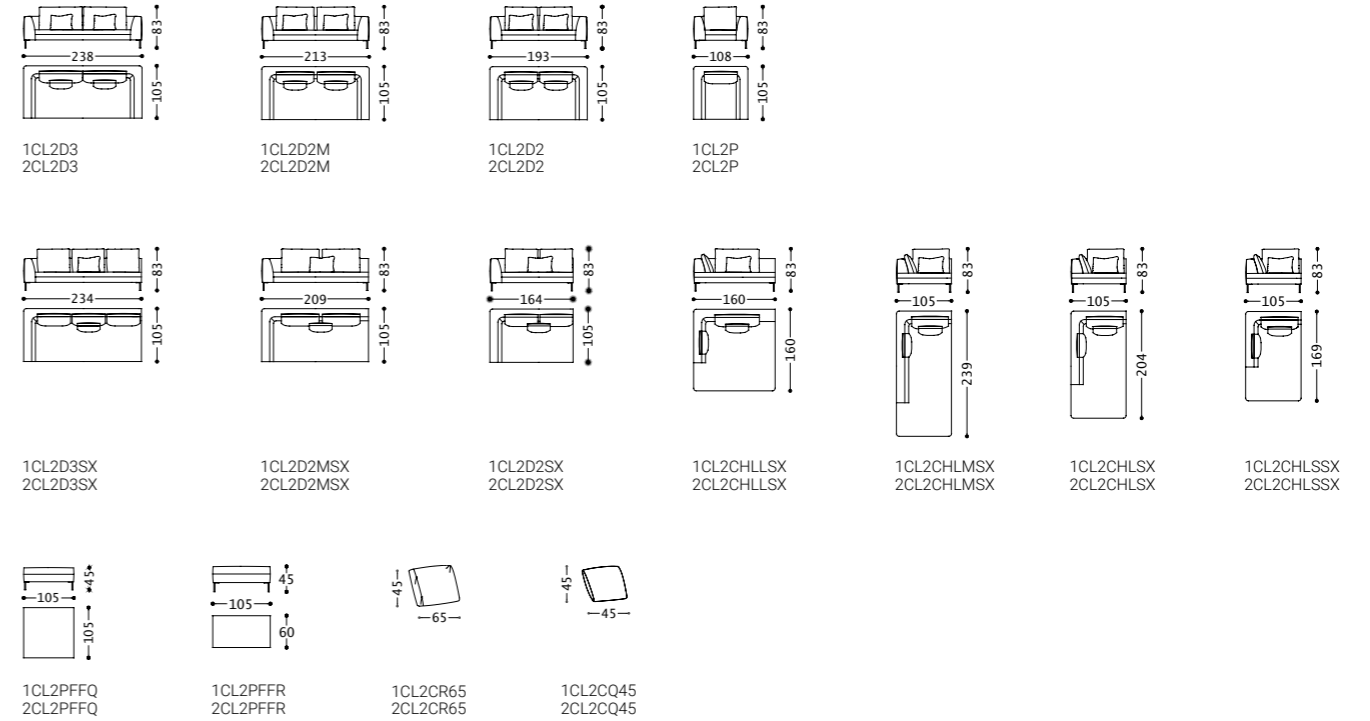

COMPOSIZIONI/COMPOSITIONS/KOMPOSITIONEN

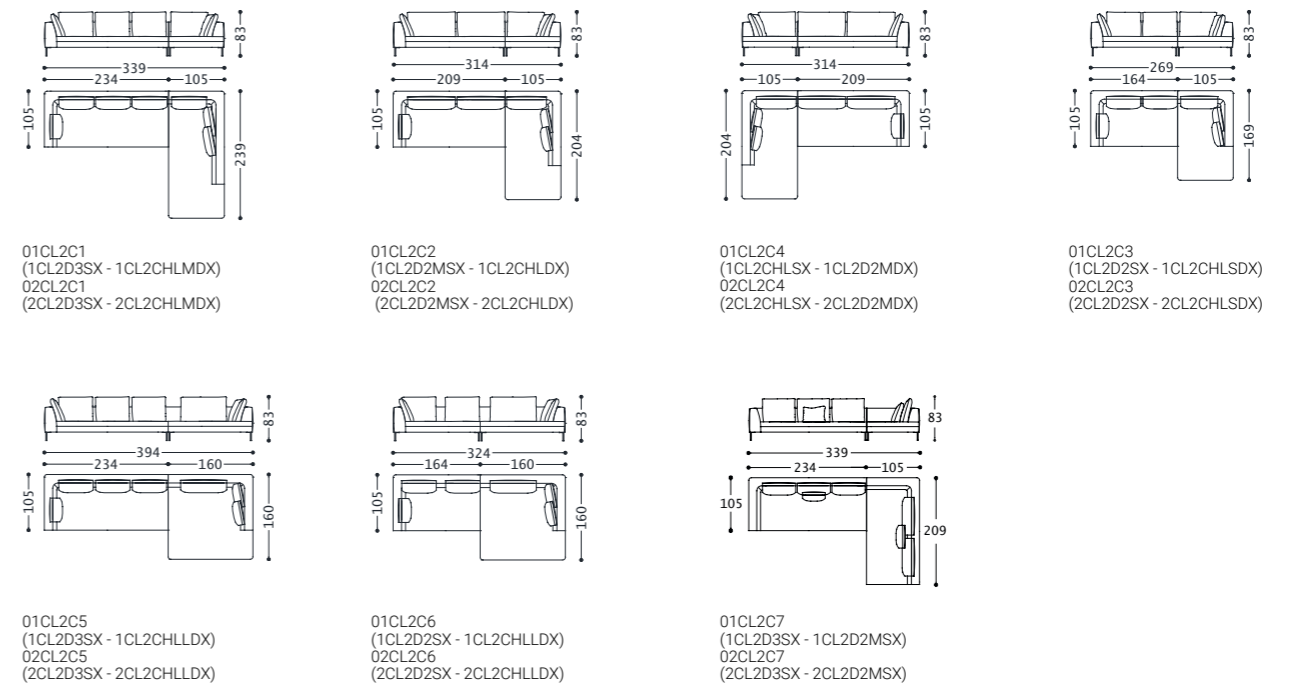

PITAGORA

divano/sofa/canapé/Sofa

designed by Golden Young Studio



PITAGORA 2 Versione senza gonna/version without flowing cut/version sans jupe/Version ohne Rock: Cod. PI2

Struttura portante: Multistrato, massello di legno.

Imbottiture: Cuscino di schienale in piuma d'oca e fibra di poliestere con inserto in poliuretano espanso rivestito in tela di cotone/poliestere. Cuscino di seduta in piuma d'oca con inserto in poliuretano espanso, rivestito in tela di cotone/ poliestere. Scocca in poliuretano espanso a densità differenziata rivestita in resinato accoppiato a vellutino.

Molleggio: Nosag in acciaio (spessore 4 mm).

Piedino: ABS nero, h. 4 cm.

Main structure: Solid wood.

Upholstery: Backrest cushion in goose feathers and polyester fiber with internal padding in polyurethane foam covered with cotton/ polyester fabric. Seat cushion in goose feathers with internal padding in polyurethane foam covered with cotton/polyester fabric. Chassis in polyurethane foam with different densities covered with resinat coupled with velvet.

Suspensions: steel Nosag (thickness 4 mm).

Feet: black ABS, h. 4 cm.

Structure: Multiplis et bois massif.

Rembourrage: Coussin de dossier en plume d'oie et fibre de polyester avec insert en mousse de polyuréthane sous housse de coton/polyester. Assise en plume d'oie avec insert en mousse de polyuréthane sous housse de coton/polyester. Chassis en mousse de polyuréthane à densités différentes revêtue de résine accouplé avec velveteen.

Suspension: Nosag en métal (épaisseur 4 mm).

Pied: En ABS noir, h. 4 cm.

Hauptstruktur: vielschichtiges Massivholz.

Polsterung: Rückenissen aus Gänsedaunen und Polyesterfaser mit Einsatz aus Polyurethanschaum mit Baumwoll/Polyester bezug verkleidet. Sitz aus aus Gänsedaunen mit Einsatz aus Polyurethanschaum mit Baumwoll/Polyester bezug verkleidet. Chassis aus Polyurethanschaum mit unterschiedlicher Dichte mit gekoppeltem Samt und Resinat verkleidet.

Federung: Nosag aus Metall (Diche 4 mm)

FüÙe: ABS schwarz, h. 4 cm.

Cod. Tessuto/fabric/tissu/Stoff: 1

Cod. Pelle/leather/cuir/Leder: 2

ELEMENTI/ELEMENTS/ÉLÉMENTS/ELEMENTE

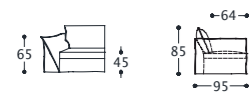

1PTGD3
2PITD3

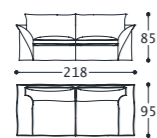

1PTGD2M
2PITD2M

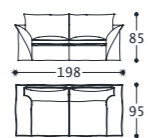

1PTGD2
2PITD2

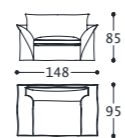

1PTGPL
2PITPL

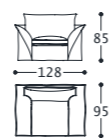

1PTGP
2PITP

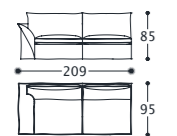

1PTGD3SX
2PITD3SX

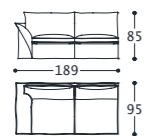

1PTGD2MSX
2PITD2MSX

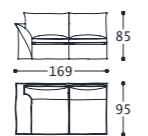

1PTGD2SX
2PITD2SX

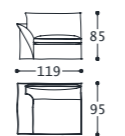

1PTGPLSX
2PITPLSX

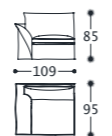

1PTGMSX
2PITPMSX

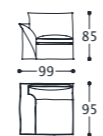

1PTGPSX
2PITPSX

PITAGORA

divano/sofa/canapé/Sofa

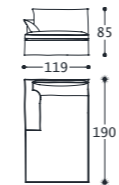

1PTGCHLSX
2PITCHLSX

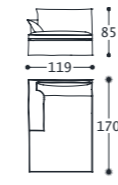

1PTGCHLSX
2PITCHLSX

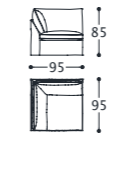

1PTGAR
2PITAR

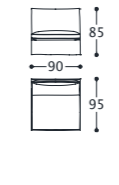

1PTGPL1
2PITPL1

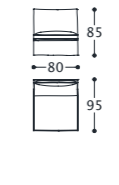

1PTGPM1
2PITPM1

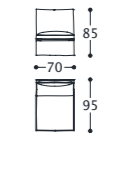

1PTGP1
2PITP1

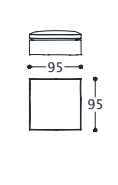

1PTGPFQ
2PITPFQ

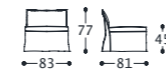

1PTGPSP
2PITPSP

COMPOSIZIONI/COMPOSITIONS/KOMPOSITIONEN

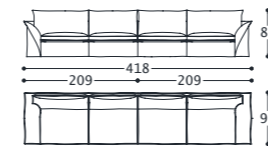

OPTGC1
(1PTGD3SX+1PTGD3DX)
OPITC1
(2PITD3SX+12PITD3DX)

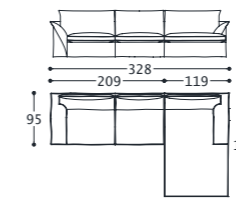

OPTGC3
(1PTGD3SX+1PTGCHLMDX)
OPITC3
(2PITD3SX+2PITCHLMDX)

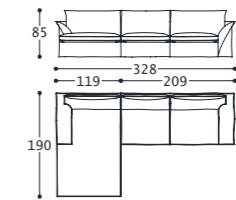

OPTGC9
(1PTGCHLSX+1PTGD3DX)
OPITC9
(2PITCHLSX+2PITD3DX)

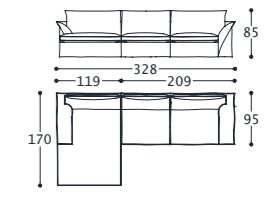

OPTGC2
(1PTGCHLSX+1PTGD3DX)
OPITC2
(2PITCHLSX+2PITD3DX)

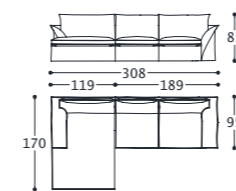

OPTGC10
(1PTGCHLSX +1PTGD2MDX)
OPITC10
(2PITCHLSX +2PITD2MDX)

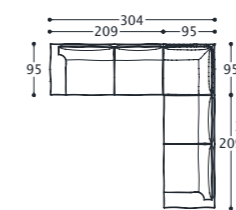

OPTGC4
(1PTGD3SX+1PTGAR+1PTGD3DX)
OPITC4
(2PITD3SX+2PITAR+2PITD3DX)

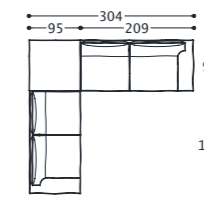

OPTGC8
(1PTGD2MSX+1PTGPFQ+1PTGD3DX)
OPITC8
(2PITD2MSX+2PITPFQ+2PITD3DX)

MANHATTAN 2

divano/sofa/canapé/Sofa

designed by Alberta Style Department



Struttura portante: Multistrato, massello di legno.
Imbottiture: Cuscino di schienale in piuma d'oca e fibra di poliestere rivestito in tela di cotone. Cuscino di seduta in poliuretano espanso a densità differenziata, rivestito in falda termolegata. Scocca in poliuretano espanso a densità differenziata rivestita in resinato accoppiato a vellutino.
Molleggio: Cinghie elastiche in polipropilene e gomma.
Piedino standard: in ABS nero, h. 4 cm (Cod. PD650).
Piedini optional: in metallo cromato, h. 4 cm (Cod. PD158).

Main structure: Solid wood.
Upholstery: Back cushion in goose feather and polyester fiber covered with cotton fabric. Seat cushion in polyurethane foam with different densities, covered with heat-boned layer. Chassis in polyurethane foam with different densities covered with resinat coupled with velvet.
Suspensions: Elastic belts in polypropylen and rubber.
Standard feet: black ABS, h. 4 cm (Cod. PD650).
Optional feet: chromed metal, h. 4 cm (Cod. PD158).

Structure: Multiplis et bois massif.
Rembourrage: Coussin de dossier en plume d'oie et fibre de polyester sous housse de coton. Coussin d'assise en mousse de polyuréthane à densités différentes revêtue en fibre thermoliée. Chassis en mousse de polyuréthane à densités différentes revêtue de résine accouplé avec velveteen.
Suspension: Sangles élastiques en polypropylène et mousse.
Pieds standard: En ABS noir, h. 4 cm (Cod. PD650).
Pieds optionnels: en métal chromé, h. 4 cm (COD.158).

Hauptstruktur: vielschichtiges Massivholz.
Polsterung: Rückenkissen aus Gänsedaunen und Polyesterfaser mit Baumwolle bezug verkleidet. Sitz aus Polyurethanschaum mit unterschiedlicher Dichte mit heiss geklebter Abdeckung. Chassis aus Polyurethanschaum mit unterschiedlicher Dichte mit gekoppeltem Samt und Resinat verkleidet.
Federung: Elastische Gurte aus Gummi und Polypropylen.
Standard Füße: ABS schwarz, h. 4 cm. (Cod. PD650)
Optional Füße: aus Metall verchromt, h. 4 cm (COD.158).

Cod. Tessuto/fabric/tissu/Stoff: 1/01
 Cod. Pelle/leather/cuir/Leder: 2/02

PIEDINI/FEET/PIEDS/FÜßE



PD158
 (optional)

ELEMENTI/ELEMENTS/ÉLÉMENTS/ELEMENTE

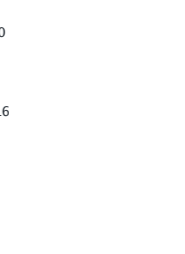
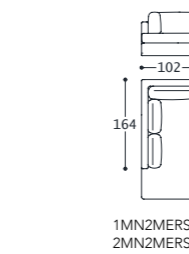
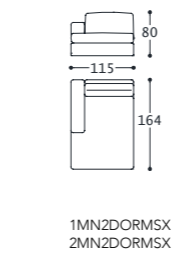
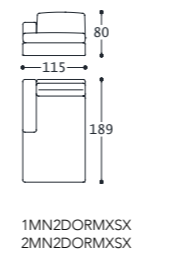
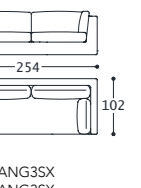
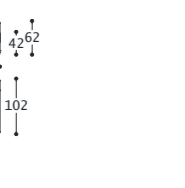
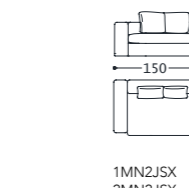
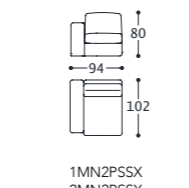
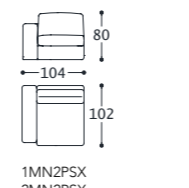
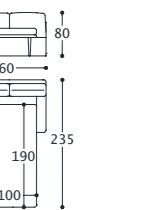
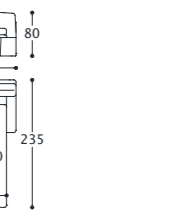
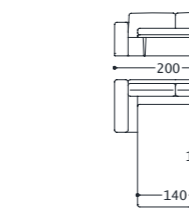
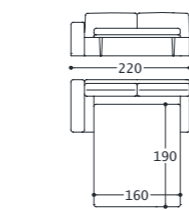
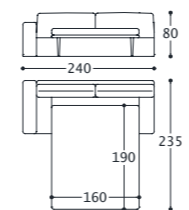
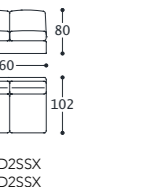
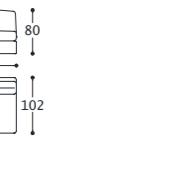
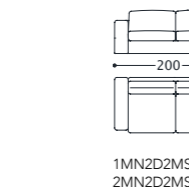
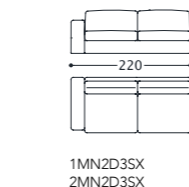
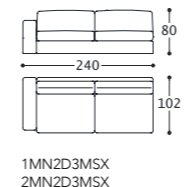
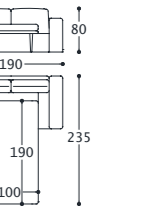
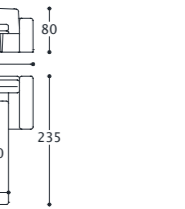
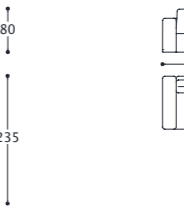
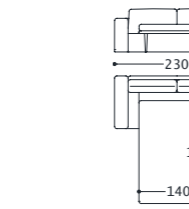
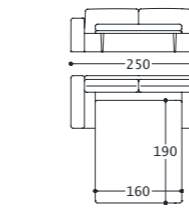
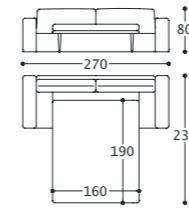
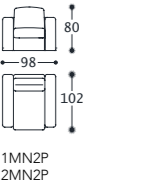
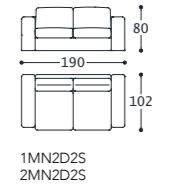
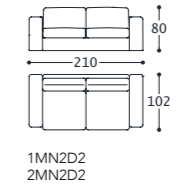
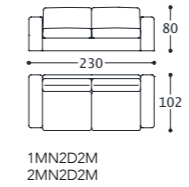
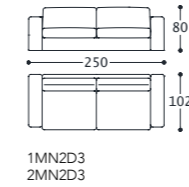
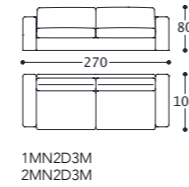
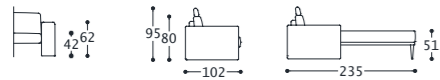

MANHATTAN 2

divano/sofa/canapé/Sofa

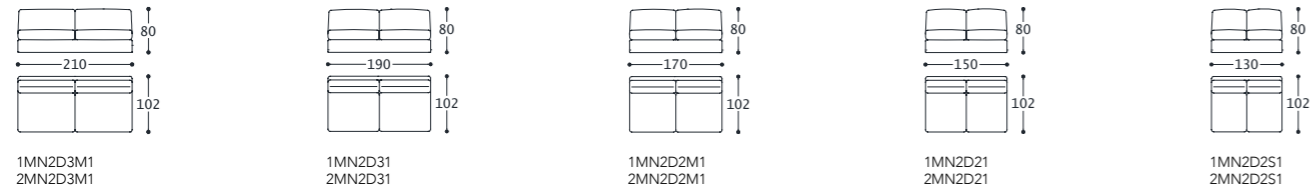

1MN2D3M1
2MN2D3M1

1MN2D31
2MN2D31

1MN2D2M1
2MN2D2M1

1MN2D21
2MN2D21

1MN2D2S1
2MN2D2S1

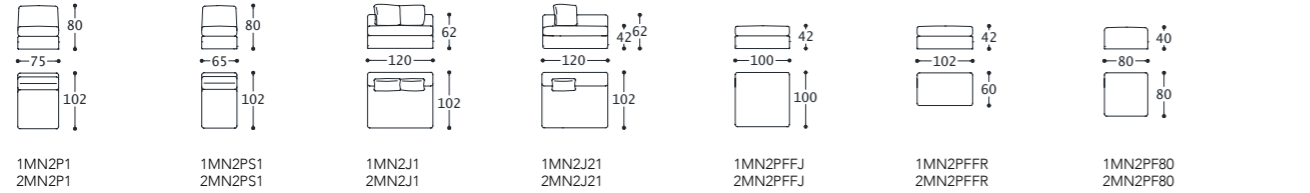

1MN2P1
2MN2P1

1MN2PS1
2MN2PS1

1MN2J1
2MN2J1

1MN2J21
2MN2J21

1MN2PFFJ
2MN2PFFJ

1MN2PFFR
2MN2PFFR

1MN2PF80
2MN2PF80

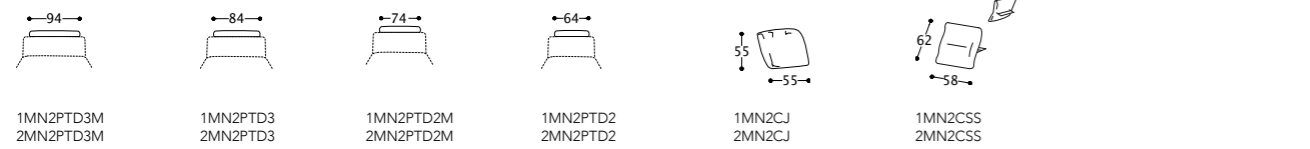

1MN2PTD3M
2MN2PTD3M

1MN2PTD3
2MN2PTD3

1MN2PTD2M
2MN2PTD2M

1MN2PTD2
2MN2PTD2

1MN2CJ
2MN2CJ

1MN2CSS
2MN2CSS

COMPOSIZIONI/COMPOSITIONS/KOMPOSITIONEN

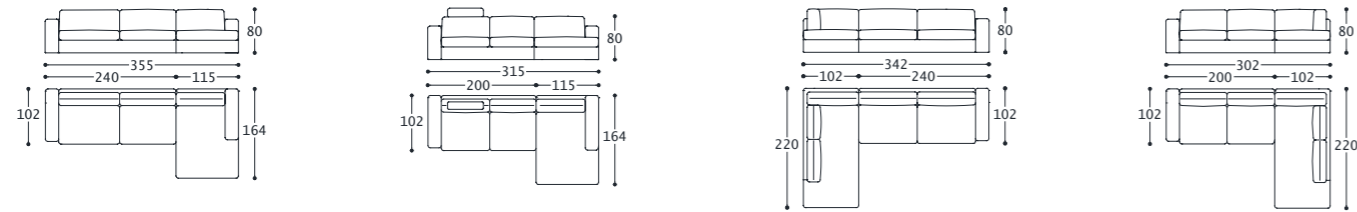

01MN2C4
(1MN2D3MSX + 1MN2DORMDX)
02MN2C4
(2MN2D3MSX + 2MN2DORMDX)

01MN2C1
(1MN2D2MSX + 1MN2DORMDX + 1MN2PTD2M)
02MN2C1
(2MN2D2MSX + 2MN2DORMDX + 2MN2PTD2M)

01MN2C9
(1MN2MERSX + 1MN2D3MDX)
02MN2C9
(2MN2MERSX + 2MN2D3MDX)

01MN2C7
(1MN2D2MSX + 1MN2MERDX)
02MN2C7
(2MN2D2MSX + 2MN2MERDX)

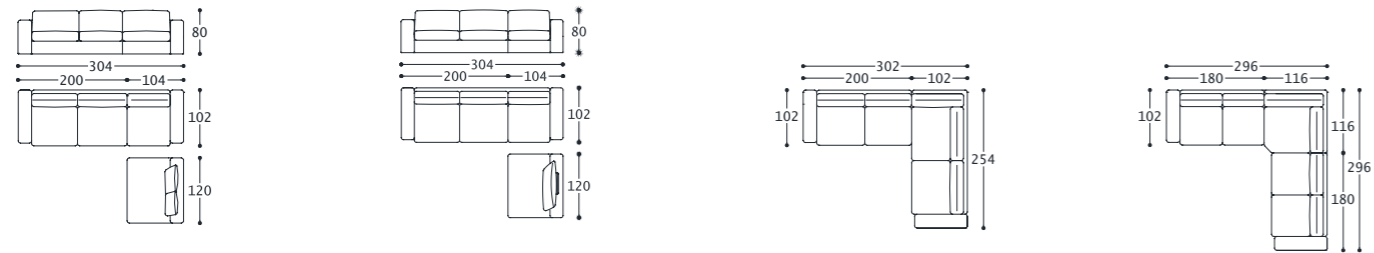

01MN2C2
(1MN2D2MSX + 1MN2J1 + 1MN2PDX)
02MN2C2
(2MN2D2MSX + 2MN2J1 + 2MN2PDX)

01MN2C6
(1MN2D2MSX + 1MN2J21 + 1MN2PDX)
02MN2C6
(2MN2D2MSX + 2MN2J21 + 2MN2PDX)

01MN2C3
(1MN2D2MSX + 1MN2ANG3DX)
02MN2C3
(2MN2D2MSX + 2MN2ANG3DX)

01MN2C5
(1MN2D2SX + 1MN2AR + 1MN2D2DX)
02MN2C5
(2MN2D2SX + 2MN2AR + 2MN2D2DX)

BROADWAY 2

divano/sofa/canapé/Sofa

designed by Alberta Style Department



Struttura portante: Multistrato, massello di legno.
Imbottiture: Cuscino di schienale in piuma d'oca e fibra di poliestere rivestito in tela di cotone. Cuscino di seduta in poliuretano espanso a densità differenziata, rivestito in falda termolegata. Scocca in poliuretano espanso a densità differenziata rivestita in resinato accoppiato a vellutino.
Molleggio: Cinghie elastiche in polipropilene e gomma.
Piedino standard: in ABS nero, h. 4 cm (Cod. PD650).
Piedini optional: in metallo cromato, h. 4 cm (Cod. PD159).

Main structure: Solid wood.
Upholstery: Back cushion in goose feather and polyester fiber covered with cotton fabric. Seat cushion in polyurethane foam with different densities, covered with heat-boned layer. Chassis in polyurethane foam with different densities covered with resinat coupled with velvet.
Suspensions: Elastic belts in polypropylen and rubber.
Standard feet: black ABS, h. 4 cm (Cod. PD650).
Optional feet: chromed metal, h. 4 cm (Cod. PD159).

Structure: Multiplis et bois massif.
Rembourrage: Coussin de dossier en plume d'oie et fibre de polyester sous housse de coton. Coussin d'assise en mousse de polyuréthane à densités différentes revêtue en fibre thermoliée. Chassis en mousse de polyuréthane à densités différentes revêtue de résine accouplé avec velveteen.
Suspension: Sangles élastiques en polypropylène et mousse.
Pieds standard: En ABS noir, h. 4 cm (Cod. PD650)
Pieds optionnels: en métal chromé, h. 4 cm (COD.159).

Hauptstruktur: vielschichtiges Massivholz.
Polsterung: Rückenkissen aus Gänsedaunen und Polyesterfaser mit Baumwolle bezug verkleidet. Sitz aus Polyurethanschaum mit unterschiedlicher Dichte mit heiss geklebter Abdeckung. Chassis aus Polyurethanschaum mit unterschiedlicher Dichte mit gekoppeltem Samt und Resinat verkleidet.
Federung: Elastische Gurte aus Gummi und Polypropylen.
Standard Füße: ABS schwarz, h. 4 cm. (Cod. PD650)
Optional Füße: aus Metall verchromt, h. 4 cm (COD.159).

Cod. Tessuto/fabric/tissu/Stoff: 1/01
 Cod. Pelle/leather/cuir/Leder: 2/02

PIEDINI/FEET/PIEDS/FÜßE



PD159
(optional)

ELEMENTI/ELEMENTS/ÉLÉMENTS/ELEMENTE

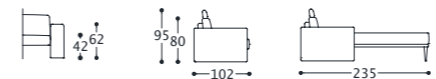

BROADWAY 2

divano/sofa/canapé/Sofa

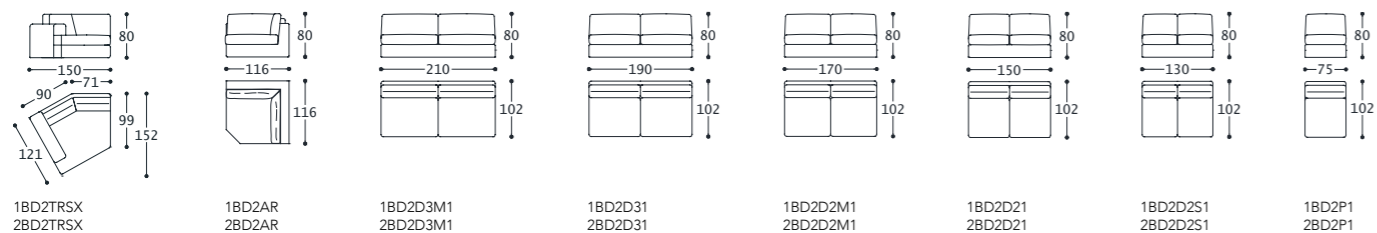
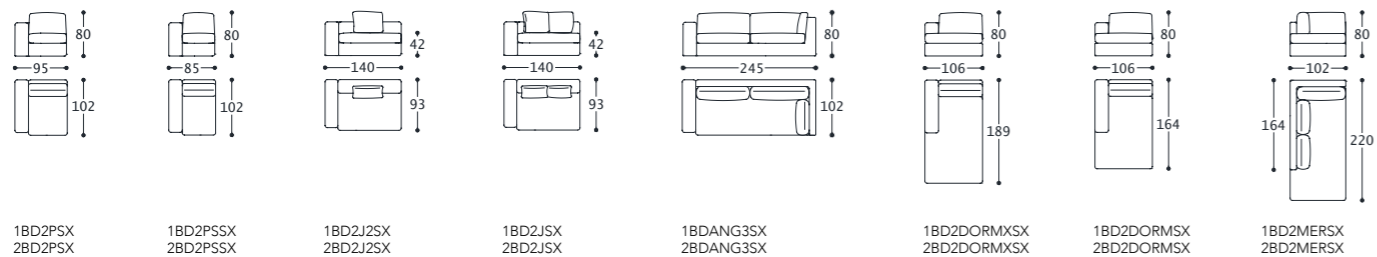
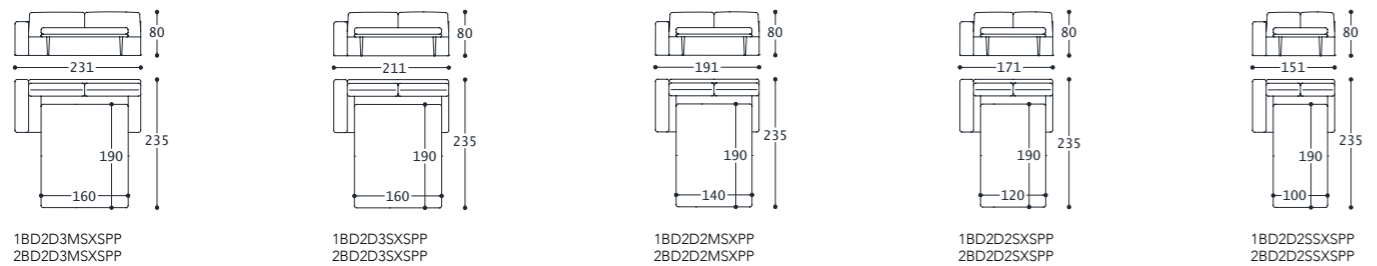
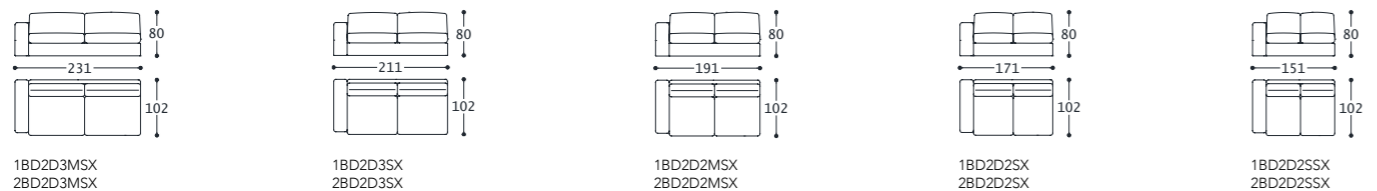
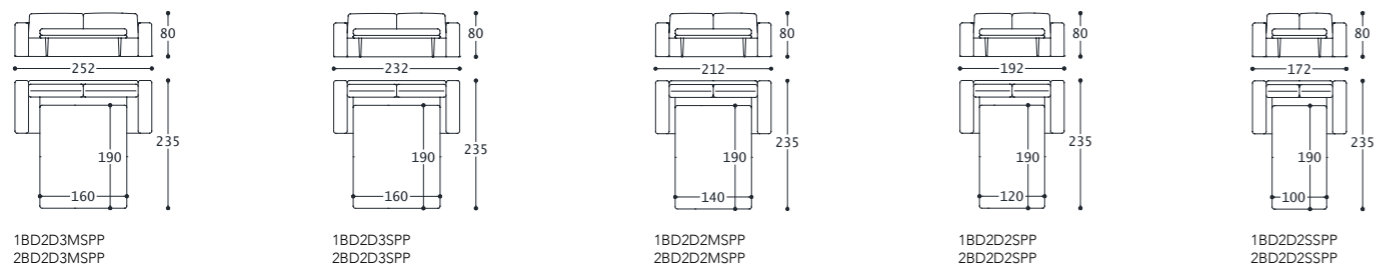
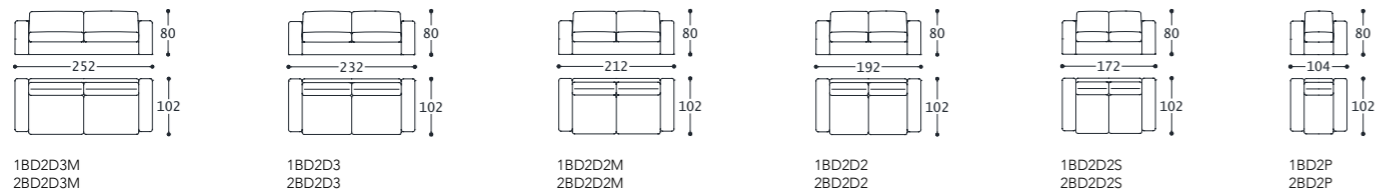

BROADWAY 2

divano/sofa/canapé/Sofa

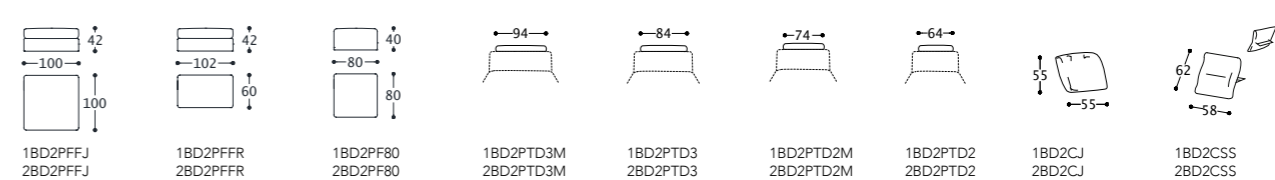
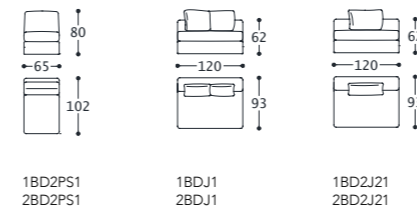

COMPOSIZIONI/COMPOSITIONS/KOMPOSITIONEN

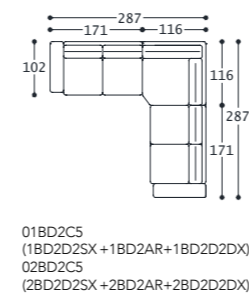
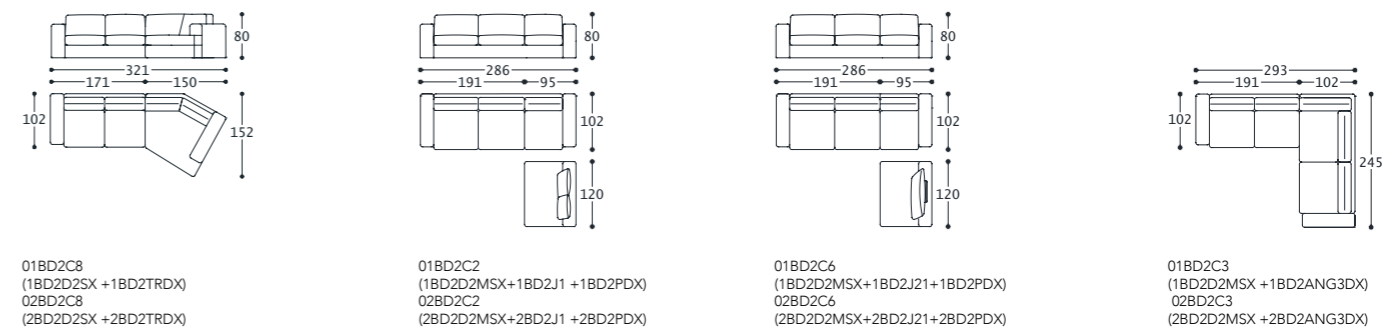
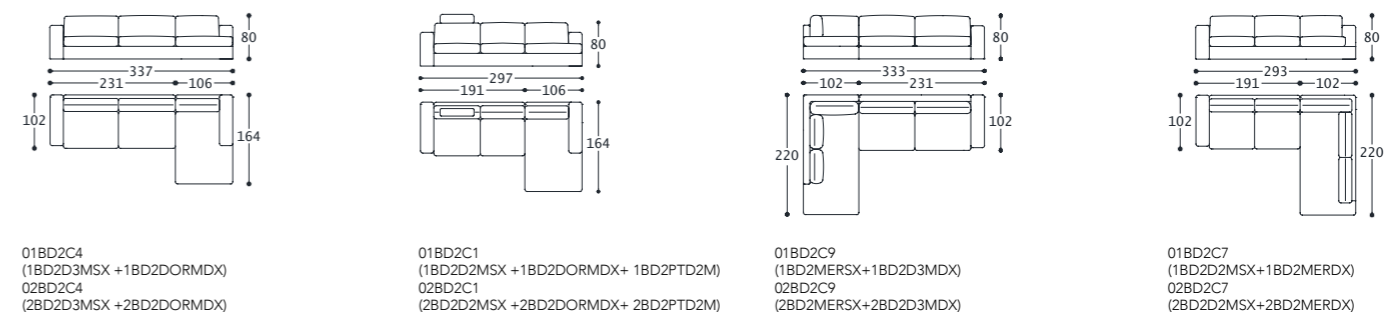

THEO

divano/sofa/canapé/Sofa

designed by Golden Young Studio



THEO 2 Versione senza gonna/version without flowing cut/version sans jupe/Version ohne Rock: Cod. TH2

Struttura portante: Multistrato, massello di legno.

Imbottiture: Schienale in poliuretano espanso (densità 23 Kg/mc), piuma d'oca e fibra di poliestere. Seduta in poliuretano espanso (densità 35 Kg/mc), piuma d'oca e fibra di poliestere. Scocca in poliuretano espanso a densità differenziata rivestito in falda termolegata da 300 gr.

Versione divano-letto: È dotato di rete elettrosaldata e materasso in poliuretano espanso ad alta densità.

Molleggio: Cinghie elastiche in polipropilene e gomma.

Piedino: ABS.

Main structure: Solid and multilayer wood.

Upholstery: Back cushion in polyurethane foam (density 23 Kg/mc), goose feather and polyester fiber. Seat cushion in polyurethane foam (density 35 Kg/mc), goose feather and polyester fiber. Chassis in polyurethane foam with different densities covered with heat-bonded layer 300 grams.

Sofa-bed version: It is equipped with electrically-welded spring and high density polyurethane foam mattress.

Suspensions: Elastic belts in polypropylen and rubber.

Feet: ABS.

Structure: Multiplis et bois massif.

Rembourrage: Dossier en mousse de polyuréthane (densité 23 kg/mc), plume d'oie et fibre de polyester. Assise en mousse de polyuréthane (densité 35 kg/mc), plume d'oie et fibre de polyester. Chassis en mousse de polyuréthane avec plusieurs densités revêtue en fibre thermoliée 300 gr.

Version lit: il est doté de sommier electrosoudé et matelas en mousse de polyuréthane haute densité.

Suspension: Sangles élastiques en polypropylène et mousse.

Pied: ABS.

Struktur: Vielschichtiges Massivholz.

Polsterung: Rückenlehne aus Polyurethanschaum (Dichte 23 kg/mc), Gänsedaunen und Polyesterfaser. Sitz aus Polyurethanschaum (Dichte 35 kg/mc), Gänsedaunen und Polyesterfaser. Chassis aus Polyurethanschaum mit unterschiedlicher Dichte mit heiss geklebter Abdeckung 300 Gramm.

Schlafsofa-Version: mit elektrogeschweißtem Lattenrost und Matratze aus Polyurethanschaum hoher Dichte.

Federung: Elastische Gurte aus Gummi und Polypropylen.

FüÙe: ABS.

Cod. Tessuto/fabric/tissu/Stoff: 1

Cod. Pelle/leather/cuir/Leder: 2

ELEMENTI/ELEMENTS/ÉLÉMENTS/ELEMENTE

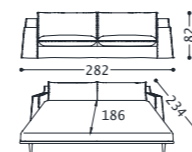
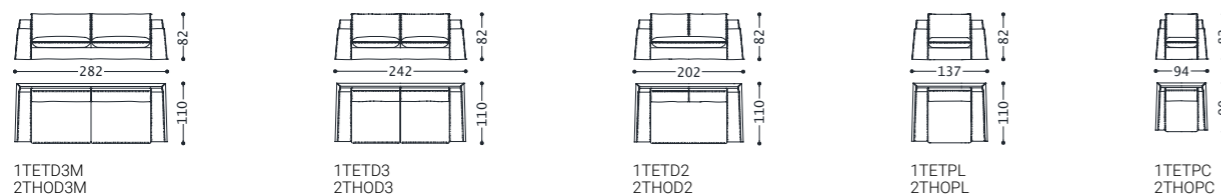

1TETD3MEP
2THOD3MEP

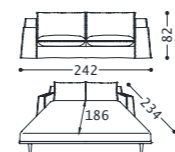

1TETD3EP
2THOD3EP

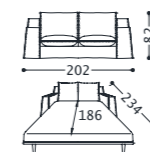

1TETD2EP
2THOD2EP

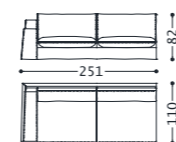

1TETD3MSX
2THOD3MSX

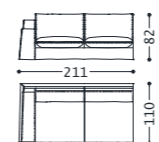

1TETD3SX
2THOD3SX

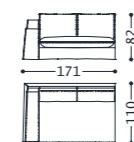

1TETD2SX
2THOD2SX

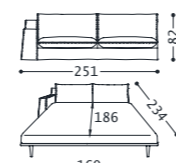

1TETD3MSXEP
2THOD3MSXEP

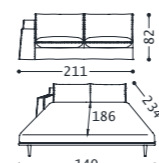

1TETD3SXEP
2THOD3SXEP

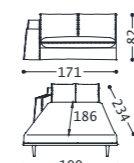

1TETD2SXEP
2THOD2SXEP

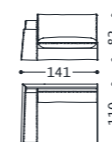

1TETPMSX
2THOPMSX

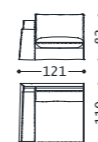

1TETPSX
2THOPSX

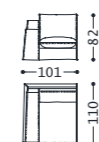

1TETPSSX
2THOPSSX

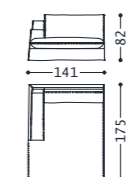

2THODORMXSX

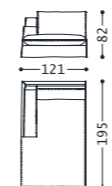

1TETDORMSX
2THODORMSX

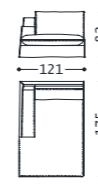

1TETDORSSX
2THODORSSX

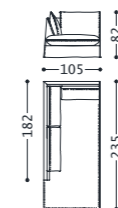

1TETMERSX
2THOMERSX

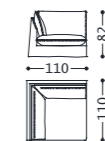

1TETAR
2THOAR

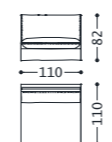

1TETPM1
2THOPM1

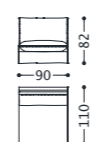

1TETP1
2THOP1

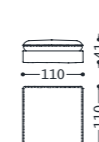

1TETPFFQ
2THOPFFQ

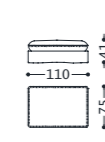

1TETPFFR
2THOPFFR

THEO

divano/sofa/canapé/Sofa

THEO SLIM

divano/sofa/canapé/Sofa

designed by Golden Young Studio

COMPOSIZIONI/COMPOSITIONS/KOMPOSITIONEN

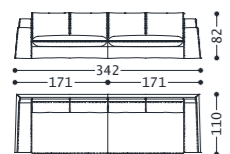

0TETC5
(1TETD2SX + 1TETD2DX)
0THOC5
(2THOD2SX + 2THOD2DX)

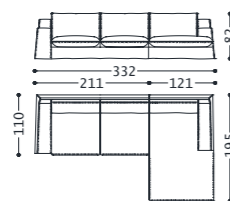

0TETC1
(1TETD3SX + 1TETDORMDX)
0THOC1
(2THOD3SX + 2THODORMDX)

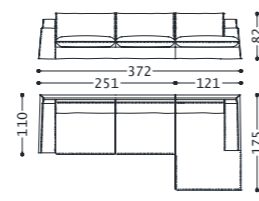

0TETC7
(1TETD3MSX + 1TETDORSDX)
0THOC7
(2THOD3MSX + 2THODORSDX)

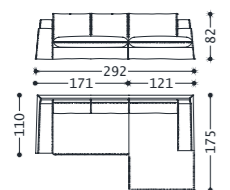

0TETC6
(1TETD2SX + 1TETDORSDX)
0THOC6
(2THOD2SX + 2THODORSDX)

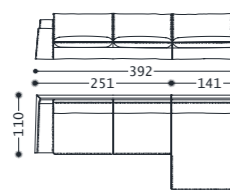

0THOC3
(2THOD3MSX + 2THODORMDX)

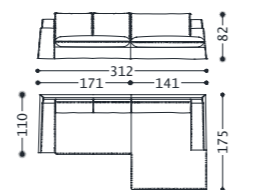

0THOC2
(2THOD2SX + 2THODORMDX)

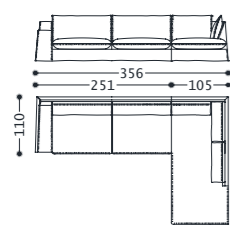

0TETC4
(1TETD3MSX + 1TETMERDX)
0THOC4
(2THOD3MSX + 2THOMERDX)

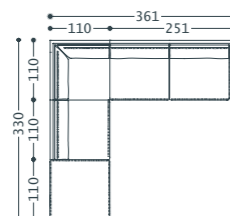

0TETC9
(1TETPPFQ + 1TETPM1 + 1TETAR + 1TETD3MDX)
0THOC9
(2THOPPFQ + 2THOPM1 + 2THOAR + 2THOD3MDX)

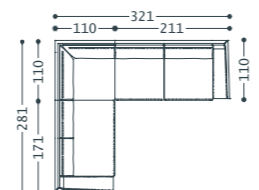

0TETC8
(1TETD2SX + 1TETAR + 1TETD3DX)
0THOC8
(2THOD2SX + 2THOAR + 2THOD3DX)



THEO SLIM 2 Versione senza gonna/version without flowing cut/version sans jupe/Version ohne Rock: Cod. TS2

Struttura portante: Multistrato, massello di legno.
Imbottiture: Schienale in poliuretano espanso (densità 23 Kg/mc), piuma d'oca e fibra di poliestere. Seduta in poliuretano espanso (densità 35 Kg/mc), piuma d'oca e fibra di poliestere. Scocca in poliuretano espanso a densità differenziata rivestito in falda termolegata da 300 gr.
Versione divano-letto: È dotato di rete elettrosaldata e materasso in poliuretano espanso ad alta densità.
Molleggio: Cinghie elastiche in polipropilene e gomma.
Piedino: ABS.

Main structure: Solid and multilayer wood.
Upholstery: Back cushion in polyurethane foam (density 23 Kg/mc), goose feather and polyester fiber. Seat cushion in polyurethane foam (density 35 Kg/mc), goose feather and polyester fiber. Chassis in polyurethane foam with different densities covered with heat-bonded layer 300 grams.
Sofa-bed version: It is equipped with electrically-welded spring and high density polyurethane foam mattress.
Suspensions: Elastic belts in polypropylene and rubber.
Feet: ABS.

Structure: Multiplis et bois massif.
Rembourrage: Dossier en mousse de polyuréthane (densité 23 kg/mc), plume d'oie et fibre de polyester. Assise en mousse de polyuréthane (densité 35 kg/mc), plume d'oie et fibre de polyester. Chassis en mousse de polyuréthane avec plusieurs densités revêtue en fibre thermolée 300 gr.
Version lit: il est doté de sommier electrosoudé et matelas en mousse de polyuréthane haute densité.
Suspension: Sangles élastiques en polypropylène et mousse.
Pied: ABS.

Struktur: Vielschichtiges Massivholz.
Polsterung: Rückenlehne aus Polyurethanschaum (Dichte 23 kg/mc), Gänsedaunen und Polyesterfaser. Sitz aus Polyurethanschaum (Dichte 35 kg/mc), Gänsedaunen und Polyesterfaser. Chassis aus Polyurethanschaum mit unterschiedlicher Dichte mit heiss geklebter Abdeckung 300 Gramm.
Schlafsofa-Version: mit elektrogeschweißtem Lattenrost und Matratze aus Polyurethanschaum hoher Dichte.
Federung: Elastische Gurte aus Gummi und Polypropylen.
Füße: ABS.

Cod. Tessuto/fabric/tissu/Stoff: 1
Cod. Pelle/leather/cuir/Leder: 2

ELEMENTI/ELEMENTS/ÉLÉMENTS/ELEMENTE

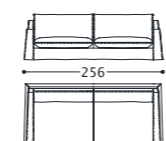
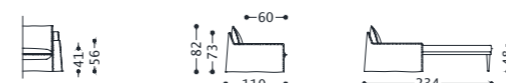

1TSLD3M
2THSD3M



1TSLD3
2THSD3

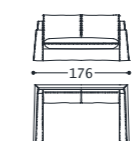

1TSLD2
2THSD2

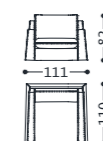

1TSLPL
2THSPL



1TSLPC
2THSPC

THEO SLIM

divano/sofa/canapé/Sofa

THEO SLIM

divano/sofa/canapé/Sofa

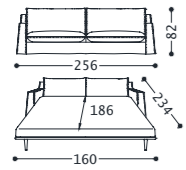

1TSLD3MEP
2THSD3MEP

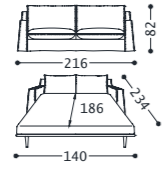

1TSLD3EP
2THSD3EP

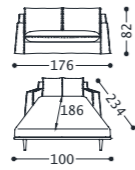

1TSLD2EP
2THSD2EP

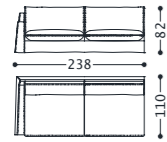

1TSLD3MSX
2THSD3MSX

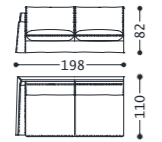

1TSLD3SX
2THSD3SX

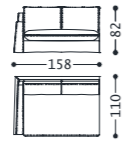

1TSLD2SX
2THSD2SX

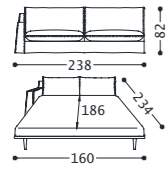

1TSLD3MSXEP
2THSD3MSXEP

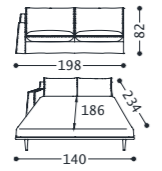

1TSLD3SXEP
2THSD3SXEP

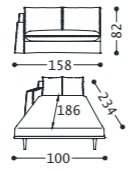

1TSLD2SXEP
2THSD2SXEP

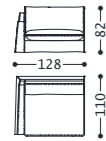

1TSLPMSX
2THSPMSX

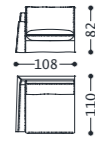

1TSLPSX
2THSPSX

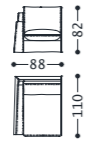

1TSLPSSX
2THSPSSX

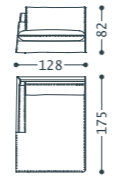

2THSDORMXSX

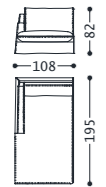

1TSLDORMSX
2THSDORMSX

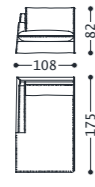

1TSLDORSSX
2THSDORSSX

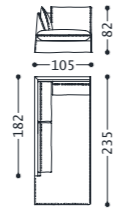

1TSLMERSX
2THSMERSX

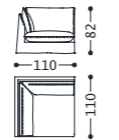

1TSLAR
2THSAR

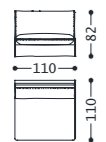

1TSLPM1
2THSPM1

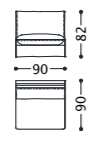

1TSLP1
2THSP1

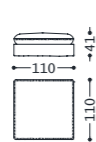

1TSLPFFQ
2THSPFFQ

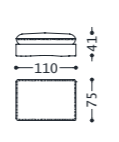

1TSLPFFR
2THSPFFR

COMPOSIZIONI/COMPOSITIONS/KOMPOSITIONEN

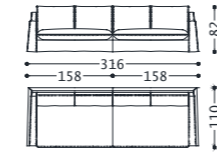

OTSLC5
(1TSLD2SX + 1TSLD2DX)
OTHSC5
(2THSD2SX + 2THSD2DX)

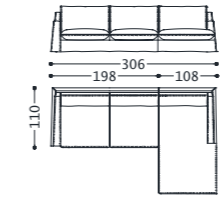

OTSLC1
(1TSLD3SX + 1TSLDORMDX)
OTHSC1
(2THSD3SX + 2THSDORMDX)

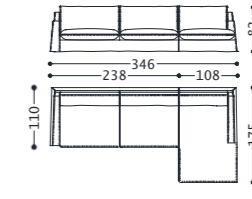

OTSLC7
(1TSLD3MSX + 1TSLDORSX)
OTHSC7
(2THSD3MSX + 2THSDORSX)

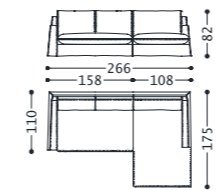

OTSLC6
(1TSLD2SX + 1TSLDORSX)
OTHSC6
(2THSD2SX + 2THSDORSX)

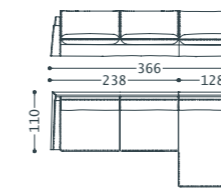

OTHSC3
(2THSD3MSX + 2THSDORMDX)

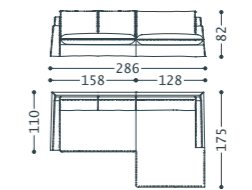

OTHSC2
(2THSD2SX + 2THSDORMDX)

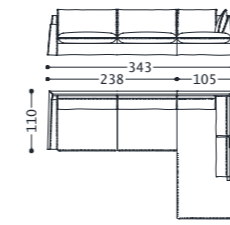

OTSLC4
(1TSLD3MSX + 1TSLMERDX)
OTHSC4
(2THSD3MSX + 2THSMERDX)

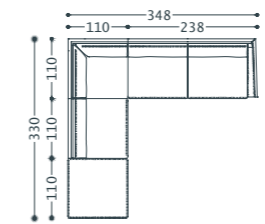

OTSLC9
(1TSLPFFQ + 1TSLPM1 + 1TSLAR + 1TSLD3MDX)
OTHSC9
(2THSPFFQ + 2THSPM1 + 2THSAR + 2THSD3MDX)

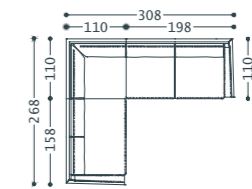

OTSLC8
(1TSLD2SX + 1TSLAR + 1TSLD3DX)
OTHSC8
(2THSD2SX + 2THSAR + 2THSD3DX)

SUMMER

divano/sofa/canapé/Sofa

designed by Alberta Style Department



Struttura portante: Multistrato, massello di legno.

Imbottiture: Cuscino di schienale in piuma d'oca, con inserto in poliuretano espanso (densità 25 Kg/mc), rivestito in tela di cotone. Cuscino di seduta in poliuretano espanso (densità 40 Kg/mc), imbottitura in piuma d'oca (50%) e fibra di poliestere cava (50%) rivestito in tela di cotone/poliestere.

Scocca in poliuretano espanso a densità differenziata rivestita in resinato 200 gr. accoppiato a vellutino.

Molle: Molle in acciaio tipo "nosag".

Piedino: ABS.

Main Structure: Solid and multilayer wood.

Upholstery: Back cushion in goose feather with internal padding in polyurethane foam (density 25 kg/mc) covered with cotton fabric. Seat cushion in polyurethane foam (density 40 kg/mc) with goose feather (50%) and polyester fiber padding (50%) covered with cotton /polyester fabric.

Chassis in polyurethane foam with different densities covered with resinated 200 grams coupled with velvet.

Suspensions: Steel springs ("nosag").

Feet: ABS.

Structure: Multiplis et bois massif.

Rembourrage: Dossier en plume d'oie avec âme en mousse de polyuréthane (densité 25 kg/mc), sous housse de coton. Assise en mousse de polyuréthane (densité 40 kg/mc), plume d'oie (50%) et fibre de polyester (50%) sous housse de coton/polyester. Chassis en mousse de polyuréthane en plusieurs densités revêtue de résiné 200 gr. accouplé avec velveteen.

Suspension: Ressorts en acier ("nosag").

Pied: ABS.

Struktur: Vielschichtiges Massivholz.

Polsterung: Rückenkissen aus Daunen mit Einsatz aus Polyurethanschaum (Dichte 25 kg/mc), mit einem Baumwolltuch abgedeckt. Sitzkissen aus Polyurethanschaum (Dichte 40 kg/mc), Füllung mit Gänsedaunen (50%) und Polyester- Hohlfasern (50%) mit Baumwolle /Polyester Bezug abgedeckt. Chassis aus Polyurethanschaum mit unterschiedlicher Dichte mit gekoppeltem Resinat 200 Gramm und Samt verkleidet.

Federsystem: Stahlfedern Typ "Nosag".

FüÙe: ABS.

Cod. Tessuto/fabric/tissu/Stoff: 1

Cod. Pelle/leather/cuir/Leder: 2

ELEMENTI/ELEMENTS/ÉLÉMENTS/ELEMENTE

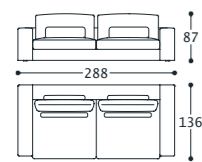
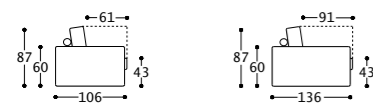

1SMMD3MPR
2SMRD3MPR

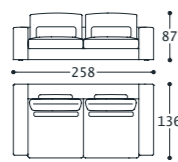

1SMMD3PR
2SMRD3PR

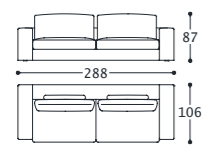

D3MSTSM
2SMRD3M

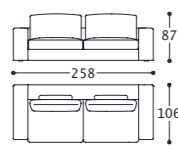

D3STSM
2SMRD3

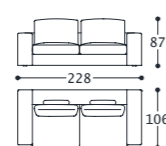

D2MSTSM
2SMRD2M

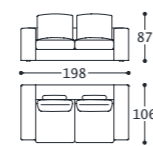

D2STSM
2SMRD2

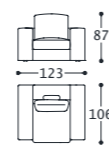

PSTSM
2SMRP

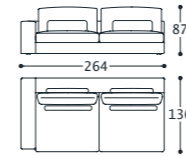

1SMMD3MPRSX
2SMRD3MPRSX

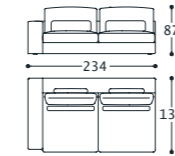

1SMMD3PRS
2SMRD3PRS

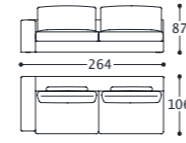

D3MSXSTSM
2SMRD3MSX

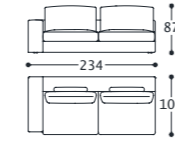

D3SXSTSM
2SMRD3SX

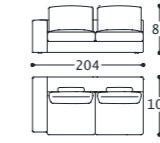

D2MSXSTSM
2SMRD2MSX

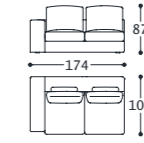

D2SXSTSM
2SMRD2SX

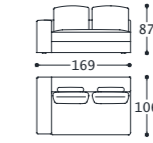

D2LSXSTSM
2SMRD2LSX

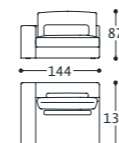

1SMMPPLRSX
2SMRPLRSX

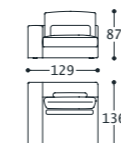

1SMMPMDPRS
2SMRPMMDPRS

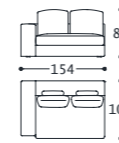

1SMMPLSX
2SMRPLSX

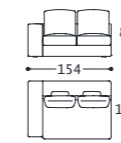

PSXJSTSM
2SMRPJSX

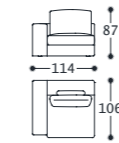

PMSXSTSM
2SMRPM SX

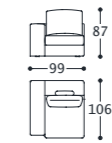

PSXSTSM
2SMRPSX

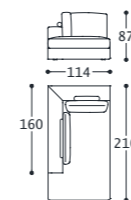

MERSXSMM
2SMRMERSX

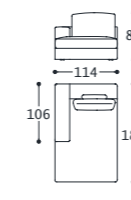

DORMXSXSMM
2SMRDORMXSX

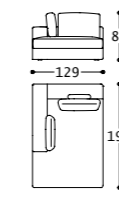

1SMMDORJLSX
2SMRDORJLSX

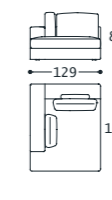

DORMXSXSMM
2SMRDORJSX

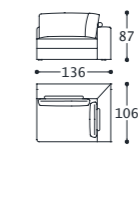

1SMMARPRS
2SMRARPRS

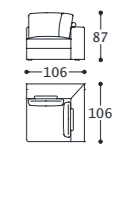

ARSTSM
2SMRAR

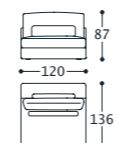

1SMMPPLR1
2SMRPLR1

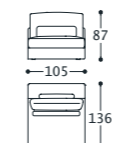

1SMMPMDPR1
2SMRPMMDPR1

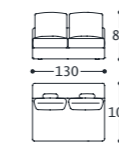

1SMMP1
2SMRPL1

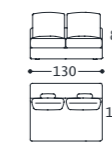

PCENJSTSM
2SMRPJ1

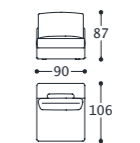

P1MSTSM
2SMRPM1

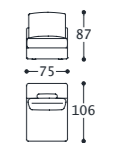

P1STSM
2SMRP1

SUMMER

divano/sofa/canapé/Sofa

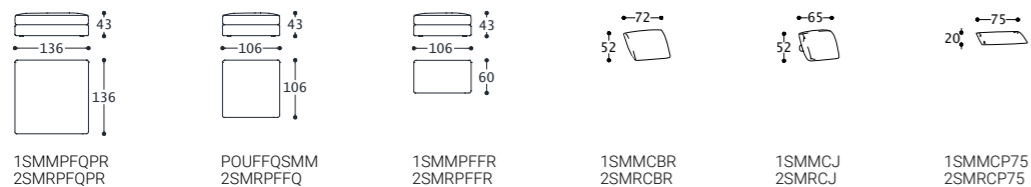

COMPOSIZIONI/COMPOSITIONS/KOMPOSITIONEN

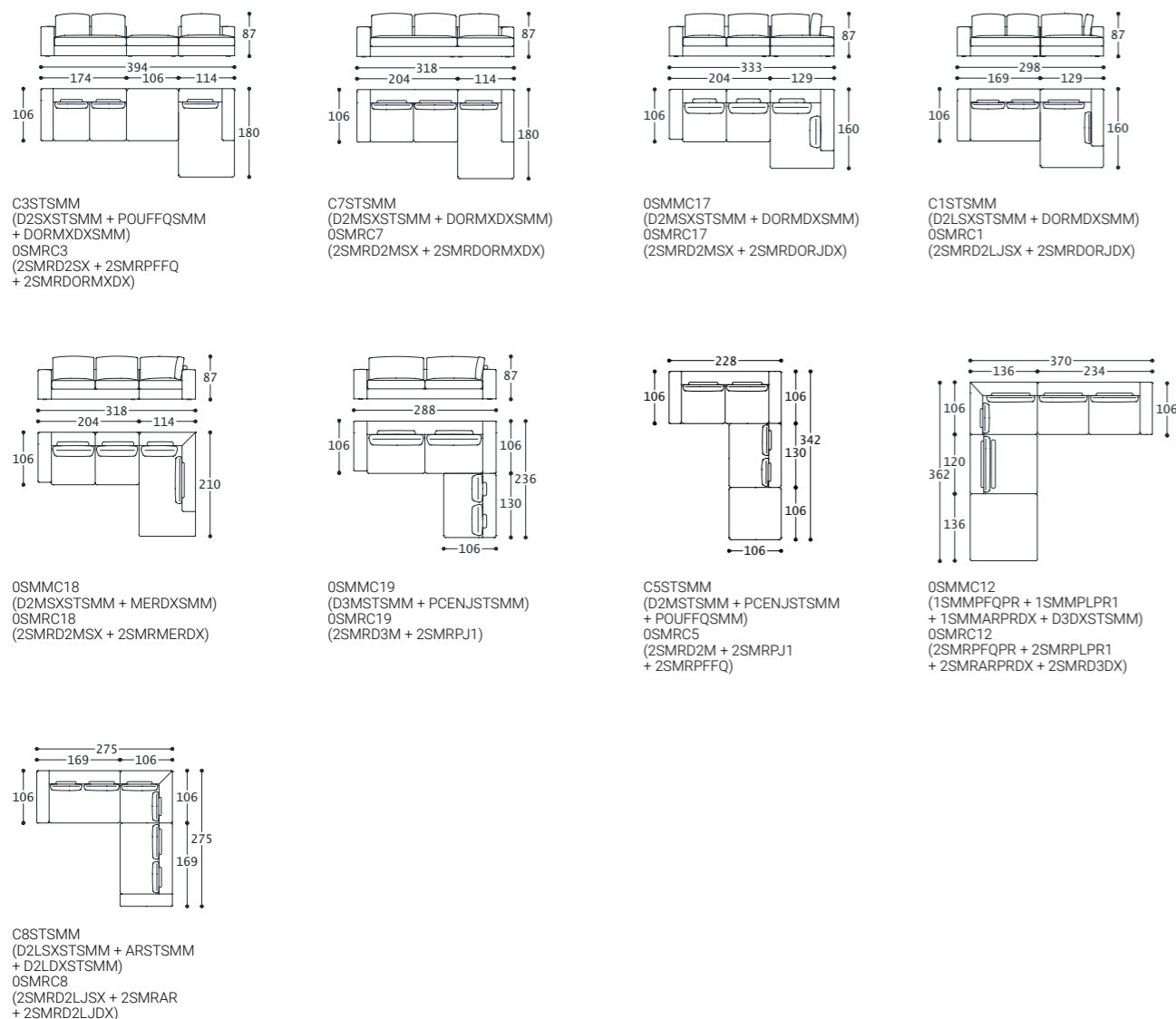

HONOLULU

poltrona relax/relax armchair/fauteuil relax/Sessel relax

designed by Alberta Style Department



POLTRONA RELAX

Struttura portante: gabbia metallica.
Imbottiture: poliuretano espanso schiumato a freddo rivestito con resinato.
Struttura esterna rivestita in multistrato impiallacciato a scelta: noce (Cod. 2HONPAGNO/2HONPAGNONV) o rovere naturale (Cod. 2HONPAGRN)
Meccanica: Schienale reclinabile con comando manuale inserito all'interno del bracciolo. Poggiatesta regolabile. Meccanismo girevole con return memory.
Basamento per poltrona relax noce: 4 razze in alluminio lucido o nero verniciato
Basamento per poltrona relax rovere naturale: 4 razze in alluminio lucido.

RELAX ARMCHAIR

Main structure: metal cage
Upholstery: cold polyurethane foam covered with resinat
Surface covered in multilayer veneer-options: walnut (Cod. 2HONPAGNO/2HONPAGNONV) or natural oak (Cod. 2HONPAGRN)
Mechanics: reclining backrest with manual mechanism placed inside the armrest. Adjustable headrest. Swivel mechanism – return memory.
Base for relax armchair-walnut: 4 legged metal frame in glossy aluminum or varnished black
Base for relax armchair-natural oak: 4 legged metal frame in glossy aluminium

FAUTEUIL RELAX

Structure de support: cage métallique
Rembourrage: mousse de polyuréthane à froid revêtu en résiné.
Structure extérieure revêtu de placage de contreplaqué à choix: noyer (Cod.2HONPAGNO/2HONPAGNONV), ou chêne naturel (Cod. 2HONPAGRN)
Mécanique: Dossier réglable, avec commande manuelle disposé a l'intérieur de l'accoudoir. Appui-tête réglable. Mécanisme pivotant avec le retour.
Base pour fauteuil relax-noyer: 4 branches en aluminium poli ou noir verni.
Base pour fauteuil relax- chêne naturel: 4 branches en aluminium poli.

SESSEL RELAX

Hauptstruktur: Metallkäfig.
Polsterung: Kaltpolyurethanschaum mit Resinat bedeckt.
Aussenstruktur aus Schichtholz furniert-Auswahl: Nussbaum (Kod. 2HONPAGNO/2HONPAGNONV) oder Eiche (Cod. 2HONPAGRN).
Mechanik: verstellbare Rückenlehne, mit manueller Steuerung im Innern der Armlehne eingefügt. Verstellbare Kopfstütze. Drehmechanismus mit "Return Memory".
Basis für Sessel relax -Nussbaum: vierspeiche aus glänzendem Aluminium oder Schwarz lackiert.
Basis für Sessel relax -Eiche: vierspeiche aus glänzendem Aluminium.

POUFF

Struttura portante: multistrato.
Imbottitura: poliuretano espanso.
Struttura esterna rivestita in multistrato impiallacciato a scelta: noce (Cod. 2HONPOUFFNO/2HONPOUFFNONV) o rovere naturale (Cod. 2HONPOUFFRN)
Basamento per pouff noce: 4 razze in alluminio lucido o nero verniciato
Basamento per pouff rovere naturale: 4 razze in alluminio lucido.

POUE

Main structure: multilayer.
Upholstery: polyurethane foam.
Surface covered in veneer-options: walnut (Cod. 2HONPOUFFNO/2HONPOUFFNONV) or natural oak (Cod. 2HONPOUFFRN)
Base for pouf-walnut: 4 legged metal frame in glossy aluminum or varnished black
Base for pouf-natural oak: 4 legged metal frame in glossy aluminium

POUE

Structure de support: multiplis.
Rembourrage: mousse de polyuréthane.
Structure extérieure revêtu de placage de contreplaqué à choix: noyer (Cod. 2HONPOUFFNO/2HONPOUFFNONV), ou chêne naturel (Cod. 2HONPOUFFRN)
Base pour pouf-noyer: 4 branches en aluminium poli ou noir verni.
Base pour pouf- chêne naturel: 4 branches en aluminium poli.

HOCKER

Hauptstruktur: Massivholz.
Polsterung: Polyurethanschaum.
Aussenstruktur aus Schichtholz furniert-Auswahl: Nussbaum (Kod.2HONPOUFFNO/2HONPOUFFNONV) oder Eiche (Kod. 2HONPOUFFRN).
Basis für Hocker-Nussbaum: vierspeiche aus glänzendem Aluminium oder Schwarz lackiert.
Basis für Hocker-Eiche: vierspeiche aus glänzendem Aluminium.

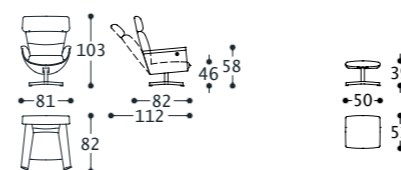

2HONPAGNO
2HONPAGNONV
2HONPAGRN

2HONPOUFFNO
2HONPOUFFNONV
2HONPOUFFRN

KALINDA

poltrona relax/relax armchair/fauteuil relax/Sessel relax

designed by Alberta Style Department



Struttura portante: multistrato, massello di legno.

Imbottiture: Schienale e seduta in poliuretano espanso (densità 30 Kg/mc) rivestito in resinato 100 gr. accoppiato a vellutino. Scocca in poliuretano espanso a densità differenziata. Poggiatesta in piuma d'oca e fibra di poliestere cava con rivestimento in tela di cotone.

Versione girevole: basamento girevole in metallo.

Main Structure: solid and multilayer wood.

Upholstery: Backrest and seat in polyurethane foam (density 30 kg/mc) covered with resinated 100 grams coupled with velvet. Chassis in polyurethane foam with different densities. Headrest in goose feather and polyester fiber covered with cotton fabric.

Swivel version: swivel metal base.

Structure: Multiplis et bois massif.

Rembourrage: Dossier et assise en mousse de polyuréthane (densité 30 kg/mc) revêtue de résiné 100 gr. accouplé avec velveteen. Chassis en mousse de polyuréthane en plusieurs densités. Appuie-tête en plume d'oie et fibre de polyester sous housse de coton.

Version tournante: piétement en métal.

Struktur: vielschichtiges Massivholz.

Polsterung: Rückenlehne und Sitz aus Polyurethanschaum (Dichte 30 kg/mc) mit gekoppeltem Resinat 100 Gramm und Samt verkleidet. Chassis aus Polyurethanschaum mit unterschiedlicher Dichte. Kopflehne aus Gänsedaunen und Polyester- Hohlfasern mit Baumwolle Bezug abgedeckt.

Dreh-Version: Metallbasis.

Cod. Tessuto/fabric/tissu/Stoff: KLT/1

Cod. Pelle/leather/cuir/Leder: KLD/2

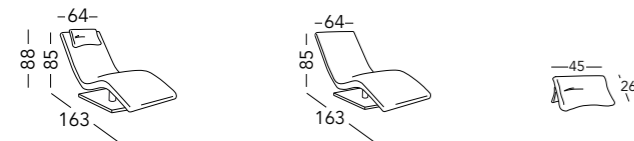

C1KLT (CHLGKLT - PTKLT)
C1PKLD (CHLGPKLD - PTPKLD)

CHLGKLT
CHLGPKLD
1KLDCHLGNV
2KLPCHLGNV

PTKLT
PTPKLD



Struttura portante: multistrato, massello di legno.

Struttura cuscino schienale: in metallo.

Imbottiture: schienale e seduta in poliuretano espanso a densità differenziata.

Molle: cinghie elastiche in polipropilene e gomma.

Gambe: in metallo.

Main structure: multilayer and solid wood.

Back cushion structure: in metal.

Upholstery: backrest and seat in polyurethane foam with different densities.

Suspensions: elastic belts in polypropylene and rubber.

Legs: in metal.

Structure: multiplis et bois massif.

Structure coussin de dossier: en métal.

Rembourrage: dossier et assise en mousse de polyuréthane en plusieurs densités.

Suspension: Sangles élastiques en polypropylène et mousse.

Jambes: en métal.

Struktur: vielschichtiges Massivholz.

Rückenkissenstruktur: aus Metall.

Polsterung: Rückenlehne und Sitz aus Polyurethanschaum in unterschiedlichen Dichte.

Federung: elastische Gurte aus Gummi und Polypropylen.

Beine: aus Metall.

Cod. Tessuto/fabric/tissu/Stoff: 1

Cod. Pelle/leather/cuir/Leder: 2

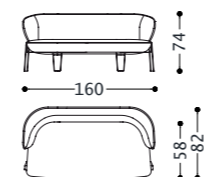
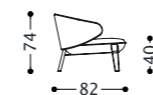

1SWJD2
2SWJD2

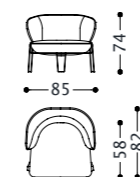

1SWJP
2SWJP

ELLE

poltrona/armchair/fauteuil/Sessel

designed by Alberta Style Department



Struttura portante: multistrato, massello di legno.

Bracciolo: in metallo con copribraccioli in pelle o tessuto (a seconda del rivestimento della poltrona).

Imbottiture: Schienale e scocca in poliuretano espanso (densità 21 Kg/mc). Seduta in poliuretano espanso (densità 35 Kg/mc).

Molleggio: cinghie elastiche in polipropilene e gomma.

Versione fissa: in metallo

Versione girevole: basamento girevole in metallo

Main Structure: solid and multilayer wood

Arm: in metal with covers in leather or fabric (according to the armchair cover).

Upholstery: Backrest and chassis in polyurethane foam (density 21 kg/mc). Seat in polyurethane foam (density 35 kg/mc).

Suspensions: elastic belts in polypropylen and rubber.

Fix version: in metal.

Swivel version: swivel metal base

Structure: multiplis et bois massif.

Accoudoir: en métal avec couvre-accoudoirs en cuir ou tissu (selon la housse du fauteuil).

Rembourrage: dossier et chassis en mousse de polyuréthane (densité 21 kg/mc). Assise en mousse de polyuréthane (densité 35 kg/mc).

Suspension: sangles élastiques en polypropylène et mousse.

Version fixe: en métal.

Version tournante: piètement en métal

Struktur: vielschichtiges Massivholz.

Armlehnen: Metall mit Abdeckungen aus Stoff oder Leder (je nach Sesselbezug).

Polsterung: Rückenlehne und Chassis aus Polyurethanschaum (Dichte 21 kg/mc). Sitz aus Polyurethanschaum (Dichte 35 kg/mc).

Federung: elastische Gurte aus Gummi und Polypropylen.

Fest-Version: aus Metall.

Dreh-Version: Metallbasis

Cod. Tessuto/fabric/tissu/Stoff: ELT/1

Cod. Pelle/leather/cuir/Leder: ELL/2

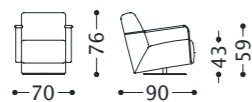
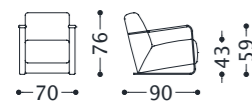

PMELT
PMPELL

PMGRELT
PMGRPELL

1ELTPNV
2ELLPNV

1ELTPGRNV
2ELLPGRNV

GOSSIP

poltrona/armchair/fauteuil/Sessel

designed by Castello Lagravinese Studio



Struttura portante: multistrato, massello di legno.

Imbottiture: Schienale e seduta in poliuretano espanso (densità 40 Kg/mc).

Molleggio: cinghie elastiche in polipropilene e gomma.

Piedino: in ABS.

Main structure: Multilayer and solid wood.

Upholstery: Backrest and seat in polyurethane foam (density 40 Kg/mc).

Suspensions: elastic belts in polypropylen and rubber.

Feet: in ABS.

Structure: Multiplis et bois massif.

Rembourrage: Dossier et assise en mousse de polyuréthane (densité 40 kg/mc).

Suspension: sangles élastiques en polypropylène et mousse.

Pied: en ABS.

Struktur: vielschichtiges Massivholz.

Polsterung: Rückenlehne und Sitz aus Polyurethanschaum (Dichte 40 Kg/mc).

Federung: elastische Gurte aus Gummi und Polypropylen.

Füße: ABS.

Cod. Tessuto/fabric/tissu/Stoff: 1

Cod. Pelle/leather/cuir/Leder: 2

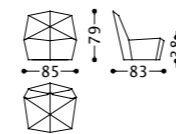

1GSPP
2GSPP

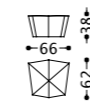

1GSPPUUFF
2GSPPUUFF

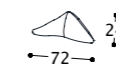

1GSPP72
2GSPP72

JAMMIN

poltrona/armchair/fauteuil/Sessel

designed by Castello Lagravinese Studio



Struttura portante: multistrato, massello di legno.
Imbottiture: Schienale in poliuretano espanso (densità 21 Kg/mc). Seduta in piuma d'oca con inserto in poliuretano espanso (densità 40 Kg/mc).
Versione fissa: piede in metallo.
Versione girevole: basamento girevole in metallo.

Main structure: Multilayer and solid wood.
Upholstery: Backrest in polyurethane foam (density 21 Kg/mc). Seat in goose feathers with internal padding in polyurethane foam (density 40 Kg/mc).
Fix version: metal feet.
Swivel version: metal base.

Structure: Multiplis et bois massif.
Rembourrage: Dossier en mousse de polyuréthane (densité 21 kg/mc). Assise en plume d'oie avec insert en mousse de polyuréthane (densité 40 kg/mc).
Version fixe: pied en métal.
Version tournante: piètement pivotant en métal.

Struktur: vielschichtiges Massivholz.
Polsterung: Rückenlehne aus Polyurethanschaum (Dichte 21 Kg/mc). Sitz aus Gänsedaunen mit Einsatz aus Polyurethanschaum (Dichte 40 Kg/mc).
Fest-Version: Fuß aus Metall.
Dreh-Version: Drehbasis aus Metall.

Cod. Tessuto/fabric/tissu/Stoff: 1
Cod. Pelle/leather/cuir/Leder: 2

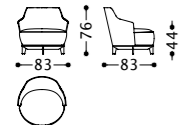

1JAMP
2JAMP

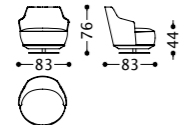

1JAMPG
2JAMPG

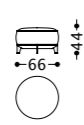

1JAMPOUFF
2JAMPOUFF

JAMMIN LARGE

poltrona/armchair/fauteuil/Sessel

designed by Castello Lagravinese Studio



Struttura portante: multistrato, massello di legno.
Imbottiture: Schienale in poliuretano espanso (densità 21 Kg/mc). Seduta in piuma d'oca con inserto in poliuretano espanso (densità 40 Kg/mc).
Versione fissa: piede in metallo.
Versione girevole: basamento girevole in metallo.

Main structure: Multilayer and solid wood.
Upholstery: Backrest in polyurethane foam (density 21 Kg/mc). Seat in goose feathers with internal padding in polyurethane foam (density 40 Kg/mc).
Fix version: metal feet.
Swivel version: metal base.

Structure: Multiplis et bois massif.
Rembourrage: Dossier en mousse de polyuréthane (densité 21 kg/mc). Assise en plume d'oie avec insert en mousse de polyuréthane (densité 40 kg/mc).
Version fixe: pied en métal.
Version tournante: piètement pivotant en métal.

Struktur: vielschichtiges Massivholz.
Polsterung: Rückenlehne aus Polyurethanschaum (Dichte 21 Kg/mc). Sitz aus Gänsedaunen mit Einsatz aus Polyurethanschaum (Dichte 40 Kg/mc).
Fest-Version: Fuß aus Metall.
Dreh-Version: Drehbasis aus Metall.

Cod. Tessuto/fabric/tissu/Stoff: 1
Cod. Pelle/leather/cuir/Leder: 2

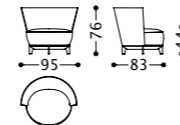

1JAMPL
2JAMPL

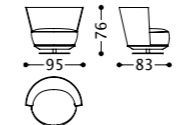

1JAMPLG
2JAMPLG



1JAMPOUFF
2JAMPOUFF

ISLAND

tavolino/small table/table/Couchtisch

designed by Castello Lagravinese Studio



Struttura: Metallo.
Top: MDF impiallacciato.

Structure: Metal.
Top: veneer MDF.

Structure: Métal.
Plateau: MDF placage.

Struktur: Metall.
Top: Furniert MDF.

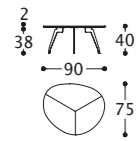

1ISNTSTS40

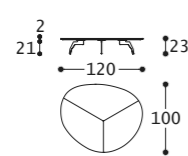

1ISNTMTS23

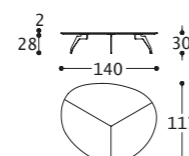

1ISNTLTS30

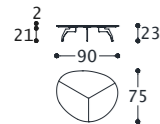

1ISNTST23

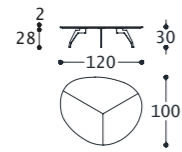

1ISNTMT30

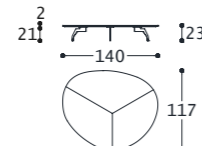

1ISNTLT23

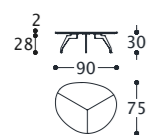

1ISNTST30

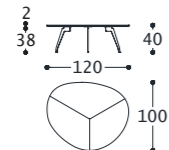

1ISNTMT40

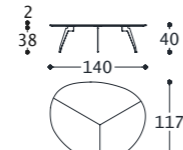

1ISNTLT40

JIMMY 3

tavolino/small table/table/Couchtisch

designed by Castello Lagravinese Studio



Struttura: metallica.
Top: MDF (laccato).

Structure: in metal.
Top: MDF (lacquered).

Structure: en métal.
Plateau: MDF (laqué).

Struktur: aus Metall.
Niedriger: MDF (lackiert).

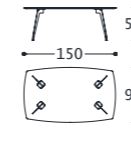

1JI3TAVRH

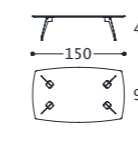

1JI3TAVRM

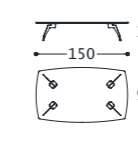

1JI3TAVRL

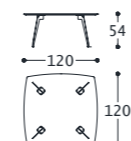

1JI3TAVQ120H

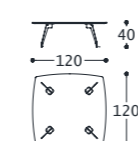

1JI3TAVQ120M

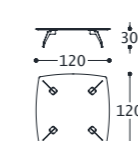

1JI3TAVQ120L

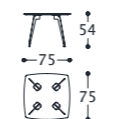

1JI3TAVQ75H

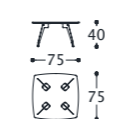

1JI3TAVQ75M

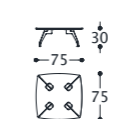

1JI3TAVQ75L

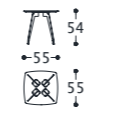

1JI3TAVQ55H

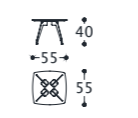

1JI3TAVQ55M

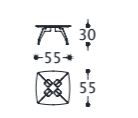

1JI3TAVQ55L

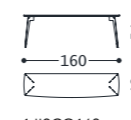

1JI3CO160



1JI3CO90

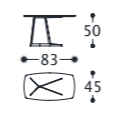

1JI3SER

ALBERT 1

tavolino/small table/table/Couchtisch

designed by Castello Lagravinese Studio



Struttura: Legno massello.
Top: Marmo

Structure: Solid wood.
Top: Marble

Structure: Bois massif.
Plateau: Marbre

Struktur: Massivholz.
Top: Marmor

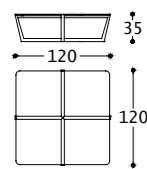

1AL1TAVQ

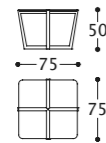

1AL1TAVQ75

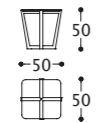

1AL1TAVQ50

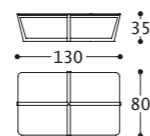

1AL1TAVR

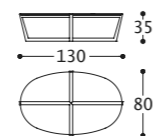

1AL1TAVOV

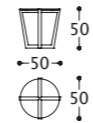

1AL1TROT50

JAGGER

tavolino/small table/table/Couchtisch

designed by Castello Lagravinese Studio



Struttura: metallica a 5 gambe.
Finitura struttura: laccato.
Top: MDF.
Finitura top: laccato.

Structure: in metal with 5 legs.
Structure finishing: lacquered.
Top: MDF.
Top finishing: lacquered.

Structure: en métal avec 5 jambes.
Finition de la structure: laqué.
Plateau: MDF.
Finition du plateau: laqué.

Struktur: aus Metall mit 5 Beine.
Strukturbearbeitung: lackiert.
Top: MDF.
Topbearbeitung: lackiert.



1JAGTH



1JAGTL



1JAGTM

PHIL

tavolino/small table/table/Couchtisch

designed by Castello Lagravinese Studio



Struttura: metallica.
Top: in marmo o MDF (laccato).

Structure: in metal.
Top: marble or MDF (lacquered).

Structure: en métal.
Plateau: marbre ou MDF (laqué).

Struktur: aus Metall.
Top: Marmor oder MDF (lackiert).



1PHISER
1PHISERL

FRISCO

tavolino/small table/table/Couchtisch

designed by Castello Lagravinese Studio



Struttura: metallica.
Top alto (1): marmo o MDF (laccato).
Top basso (2): MDF (laccato).

Structure: in metal.
Top high (1): marble or MDF (lacquered).
Top low (2): MDF (lacquered).

Structure: en métal.
Plateau haut (1): marbre ou MDF (laqué).
Plateau bas (2): MDF (laqué).

Struktur: aus Metall.
Hoher Top (1): Marmor oder MDF (lackiert).
Niedriger Top (2): MDF (lackiert).



1FRITROT
1FRITROT L



1FRITAVQA
1FRITAVQAL

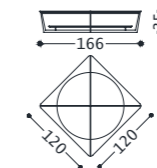

1FRITAVQB
1FRITAVQBL



1FRITAVR
1FRITAVRL

RODEO 1/RODEO 3/RODEO 5

tavolino/small table/table/Couchtisch

designed by Yonoh Creative Studio



Struttura: Metallo.
Top RODEO 1: Marmo.
Top RODEO 3: MDF laccato.
Top RODEO 5: Vetro fumé.

Structure: Metal.
Top RODEO 1: Marble.
Top RODEO 3: Lacquered MDF.
Top RODEO 5: Smoked glass.

Structure: Métal.
Plateau RODEO 1: Marbre.
Plateau RODEO 3: MDF laqué.
Plateau RODEO 5: Verre fumé.

Struktur: Metall.
Top RODEO 1: Marmor.
Top RODEO 3: MDF lackiert.
Top RODEO 5: Glas fumé.

RODEO 1



1RO1TROT5551

1RO1TROT9035

RODEO 3



1RO3TROT5551

1RO3TROT9035

RODEO 5



1RO5TROT5551

1RO5TROT9035



Product Development

Maurizio Manzoni-Studio Memo Firenze for:

Sweet Jane armchair

Castello Lagravinese Studio for:

Gossip armchair - Jammin armchair

Coffe-tables: Island - Jimmy 3 - Albert 1 - Jagger - Phil - Frisco

Yonoh Creative Studio for:

RODEO small tables

Golden Young Studio for:

Pitagora sofa - Theo/Theo Slim Sofa

Photography

Davide Cerati fotografia

Renai & Renai

emozioni. com

Styling

Sissi Valassina

Luigina Pilloni

Graphic Assistant

Bplus marketing

Print

SOLUTION

alberta

via Toniolo 41

31028 Vazzola (TV) - ITALY

T +39 0438 440440

F +39 0438 441555

www.alberta.it